

ARTESYN LCM1000 SERIES

1000 Watts Bulk Front End



PRODUCT DESCRIPTION

Advanced Energy's Artesyn LCM1000 provides a low cost solution to Industrial and Medical single output high power requirements. Full featured, the 2.4" x 5.2" x 10.0" enclosed form factor utilizes smart fans for self contained thermal management at very low acoustic noise levels. Digital Signal Processor control allows for a high level of modification flexibility. Voltage output for the series ranges from 10.8V - 52.8V at a continuous output power of 1000W. The LCM1000 also provides an optional 5V standby, conformal coating, and constant current operation.

SPECIAL FEATURES

- 1000 Watts output power
- Low cost
- 2.4" x 5.2" x 10.0"
- Industrial/medical safety
- -40 °C to 70 °C with derating
- Optional 5 Vdc @ 2 A housekeeping
- High efficiency: 90% typical
- Variable speed "smart fans"
- DSP controlled
- Full rating with reverse airflow
- Conformal coat option
- ±10% adjustment range
- Margin programming
- OR-ing FET
- Low acoustic noise
- EMI class A; class B with internal modification option
- SEMI F47 compliance at high line

SAFETY

- ULcUL, ITE(UL62368-1)
- ULcUL, medical (ANSI/AAMI ES60601-1)
- TUV-SuD ITE + medical (EN62368-1 and EN60601-1)
- CE LVD (EN60950-1 + ROHS)
- UKCA Mark
- BSMI
- CCC approval
- CB report through Demko for IEC62368-1 through TUV-SuD for IEC60601-1

COMPLIANCE

- EMI Class A; Class B with internal modification option
- EN61000 Immunity
- RoHS 3.0

AT A GLANCE

Total Power

1000 Watts

Input Voltage

90 to 264 Vac

of Outputs

Single



MODEL NUMBERS

Standard ¹	Output Voltage	Minimum Load	Maximum Load	Adjustment Range	Maximum Power
LCM1000L	12Vdc	0A	83.3A	10.8Vdc - 13.2Vdc	1000W
LCM1000N	15Vdc	0A	66.7A	13.5Vdc - 16.5Vdc	1000W
LCM1000Q	24Vdc	0A	42.0A	21.6Vdc - 26.4Vdc	1000W
LCM1000U	36Vdc	0A	27.8A	32.4Vdc - 39.6Vdc	1000W
LCM1000W	48Vdc	0A	20.8A	43.2Vdc - 52.8Vdc	1000W

Note 1 - Add "-T" for terminal block
 Add "-4" for 5V standby
 Add "-1" for conformal coating adder
 Add "-5" for conformal coating and 5V standby adder
 Add "-8" for constant current
 Add "-9" for option 1 + 8
 Add "-D" for option 4 + 8
 Add "-E" for option 1 + 4 + 8

ELECTRICAL SPECIFICATIONS

Absolute Maximum Ratings

Stress in excess of those listed in the “Absolute Maximum Ratings” may cause permanent damage to the power supply. These are stress ratings only and functional operation of the unit is not implied at these or any other conditions above those given in the operational sections of this TRN. Exposure to any absolute maximum rated condition for extended periods may adversely affect the power supply’s reliability.

Table 1. Absolute Maximum Ratings						
Parameter	Model	Symbol	Min	Typ	Max	Unit
Input Voltage AC continuous operation	All models	$V_{IN,AC}$	90	-	264	Vac
Maximum Output Power, continuous	All models	$P_{O,max}$	-	-	1000	W
Isolation Voltage (Qualification) Input to outputs (2X MOPP) Input to safety ground (1X MOPP) Outputs to safety ground	All models		-	-	4000 2087 250	Vac Vac Vdc
Isolation Voltage (Production) Input to outputs Input to safety ground Outputs to safety ground	All models All models All models		- - -	- - -	1800 1800 250	Vac Vac Vdc
Ambient Operating Temperature	All models	T_A	-40	-	+70 ¹	°C
Storage Temperature	All models	T_{STG}	-40	-	+85	°C
Humidity (non-condensing) Operating Non-operating	All models All models		20 10	- -	90 95	% %
Altitude Operating Non-operating	All models All models		- -	- -	16,404 30,000	feet feet

Note 1 - With linear 50% derating from 50 °C to 70 °C.

ELECTRICAL SPECIFICATIONS

Input Specifications

Table 2. Input Specifications						
Parameter	Condition	Symbol	Min	Typ	Max	Unit
Operating Input Voltage, AC	All	$V_{IN,AC}$	90	115/230	264	Vac
Input AC Frequency	All	f_{IN}	47	50/60	440	Hz
Maximum Input Current ($I_O = I_{O,max}$, $I_{SB} = I_{SB,max}$)	$V_{IN,AC} = 100Vac$	$I_{IN,max}$	-	-	12	A
No Load Input Current ($V_O = On$, $I_O = 0A$, $I_{SB} = 0A$)	$V_{IN,AC} = 90Vac$ $V_{IN,AC} = 264Vac$	$I_{IN,no-load}$	- -	- -	480 350	mA
No Load Input Power ($V_O = On$, $I_O = 0A$, $I_{SB} = 0A$)	$V_{IN,AC} = 90Vac$	$P_{IN,no-load}$	-	-	30	W
Harmonic Line Currents	All	THD	IEC61000-3-2			
Power Factor	$I_O = I_{O,max}$ $V_{IN,AC} = 90$ to $264Vac$	PF	-	0.99	-	
Startup Surge Current (Inrush) @ 25°C	$V_{IN,AC} = 264Vac$	$I_{IN,surge}$	-	-	25	A_{PK}
Input Fuse	Internal, L and N 250Vac rated		-	-	30	A
Input AC Low Line Start-up Voltage	$I_O = I_{O,max}$	$V_{IN,AC-start}$	85	-	90	Vac
Input AC Undervoltage Lockout Voltage	$I_O = I_{O,max}$	$V_{IN,AC-stop}$	80	-	90	Vac
PFC Switching Frequency	All	$f_{SW,PFC}$	65	-	75	KHz
Efficiency ($T_A = 25^\circ C$, forced air cooling)	$V_{IN,AC} = 230Vac$ $I_O = I_{O,max}$	η	-	90	-	%
Leakage Current to safety ground	UL test method	$I_{IN,leakage}$	-	-	0.4	mA
	IEC test method	$I_{IN,leakage}$	-	-	0.5	mA

ELECTRICAL SPECIFICATIONS

Output Specifications

Table 3. Output Specifications							
Parameter		Condition	Symbol	Min	Typ	Max	Unit
Factory Set Voltage	LCM1000L	$I_O = 0A$	$V_{O,Factory}$	11.94	12.00	12.06	Vdc
	LCM1000N			14.92	15.00	15.07	
	LCM1000Q			23.88	24.00	24.12	
	LCM1000U			35.82	36.00	36.18	
	LCM1000W			47.76	48.00	48.24	
Output Adjust Range	LCM1000L	$I_O = 0A$ See note 1	V_O	10.8	-	13.2	Vdc
	LCM1000N			13.5	-	16.5	
	LCM1000Q			21.6	-	26.4	
	LCM1000U			32.4	-	39.6	
	LCM1000W			43.2	-	52.8	
Total Regulation	See note 2		$\% V_O$	-2.0	-	+2.0	%
			$\% V_{SB}$	-4	-	+8	%
Output Ripple, pk-pk	LCM1000L	All	$I_{O,max}$	0	-	83.3	mV_{pk-pk}
	LCM1000N			0	-	66.7	
	LCM1000Q			0	-	42.0	
	LCM1000U			0	-	27.8	
	LCM1000W			0	-	20.8	
	All Models ⁴		$I_{SB,max}$	0	-	2	mV_{pk-pk}
Load Capacitance	LCM1000L	Start up	C_O	-	-	20,000	uF
	LCM1000N			-	-	16,000	
	LCM1000Q			-	-	10,000	
	LCM1000U			-	-	6,700	
	LCM1000W			-	-	5,000	
	All Models ¹		C_{SB}	-	-	270	
DC DC Switching Frequency		All	$f_{SW,DC-DC}$	125	-	145	KHz
Turn On Overshoot		$I_O = 0A$	$\%V_O$	-	-	10	%

Note 1 - See page 22 for voltage adjustment pot location

Note 2 - Inclusive of line, load temperature change, warm-up drift

Note 3 - Optional 5V Standby

Note 4 - Measure with a 0.1uF ceramic capacitor in parallel with a 10uF tantalum capacitor using a 20MHz bandwidth limited oscilloscope

ELECTRICAL SPECIFICATIONS

Output Specifications

Table 3. Output Specifications							
Parameter	Condition	Symbol	Min	Typ	Max	Unit	
Number of Parallel Units	All		-	-	10	Units	
Minimum Load for Current Sharing			1	-	-	% $I_{O,max}$	
V_O Current Share Accuracy	1% to 20% of $I_{O,max}$		25	-	75	% I_O	
	20% to 50% of $I_{O,max}$		40	-	60	% I_O	
	50% to 100% of $I_{O,max}$		45	-	55	% I_O	
V_O Dynamic Response ²	Peak Deviation Settling Time	50% load change, slew rate = 1A/us	$\pm\%V_O$	-	-	4	%
			t_s	-	-	300	uSec
Remote Sense	Maximum compensation at each output line	V_{SENSE}	-	-	500	mV	

Note 1 - Optional 5V Standby

Note 2 - Slew rate is set at 1A/uSec with a dynamic load frequency of up to 1Khz. Tested with minimum output capacitor of 1000uF on main output

ELECTRICAL SPECIFICATIONS

System Timing Specifications

Table 4. Specifications					
Label	Parameter	Min	Typ	Max	Unit
T1	Delay from AC being applied to V_{SB} being within regulation.	-	-	2000	mSec
T2	Delay from AC being applied to main output voltages being within regulation.	-	-	3000	mSec
T3	V_o rise time, 10% to 90% V_o of the nominal voltage.	5	-	50	mSec
T4	Delay from output voltages within regulation limits to G_DCOK_C asserted low.	-	-	500	mSec
T5	Hold up time - Delay from AC loss to main output within regulation (90% V_o of the nominal voltage).	20	-	-	mSec
T6	Delay from loss of AC input to G_ACOK_C going to low.	5	-	12	mSec
T7	Delay from INH_EN going to low to G_DCOK_C going to high.	-	-	10	mSec
T8	Delay from INH_EN going to low to main output without regulation (90% V_o of the nominal voltage).	-	-	50	mSec
T9	Delay from INH_EN going to high to main output within regulation (90% V_o of the nominal voltage).	-	-	500	mSec

ELECTRICAL SPECIFICATIONS

System Timing Diagram

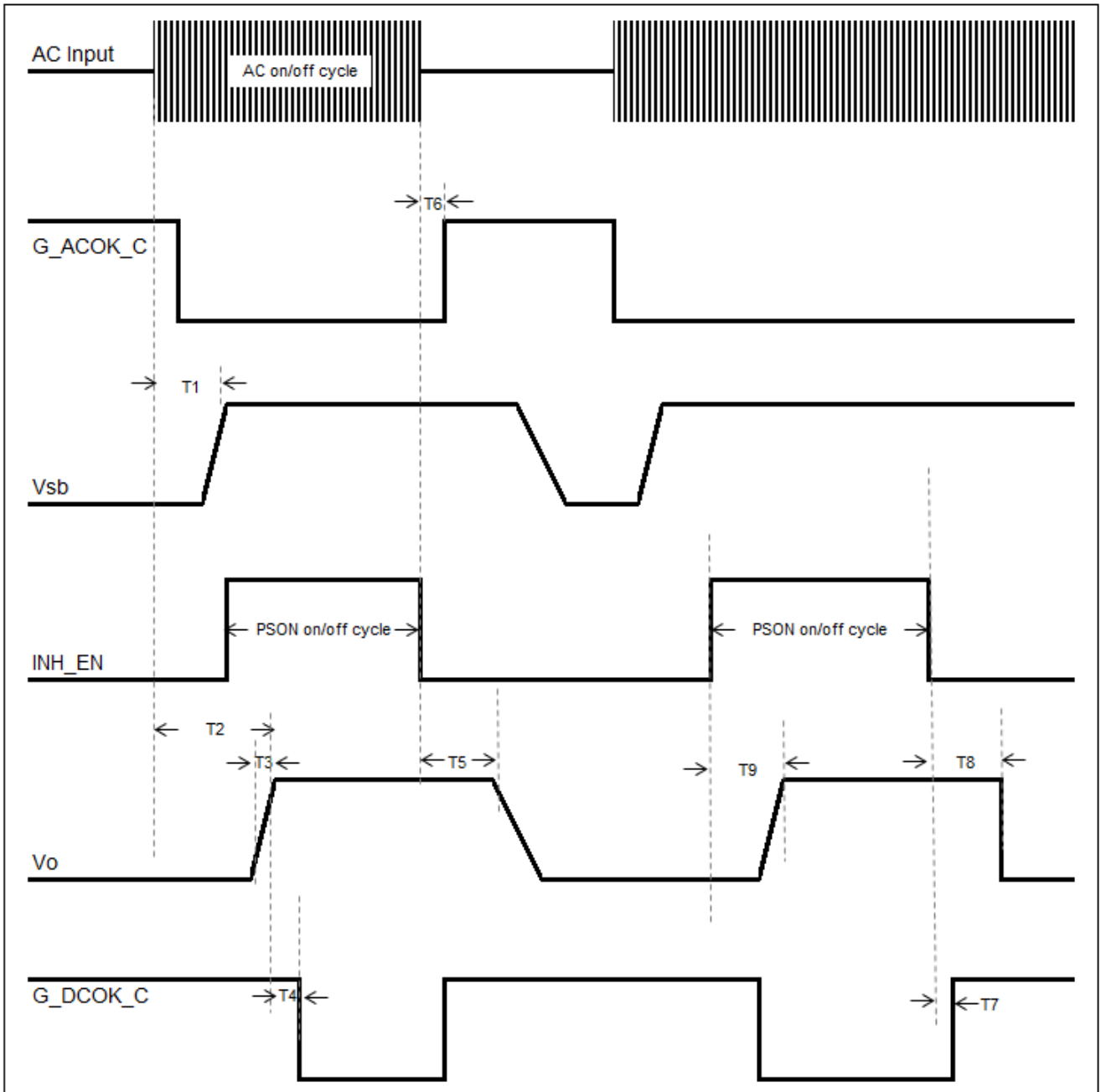

ELECTRICAL SPECIFICATIONS

LCM1000L Performance Curves

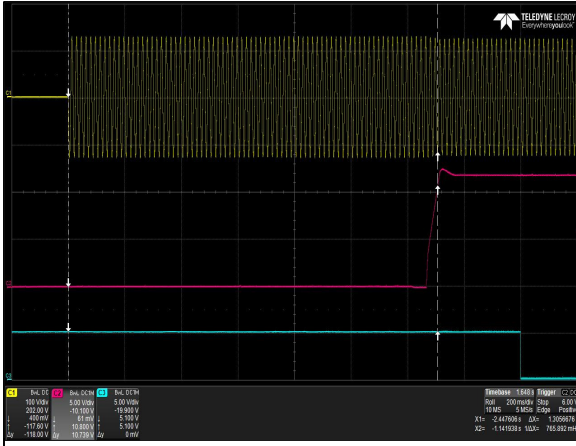

Figure 1: LCM1000L-T Turn-on delay via AC mains
 Vin = 90Vac Load: lo = 83.3A (12V)
 Ch 1: Vin Ch 2: Vo Ch 3: G_DCOK_C

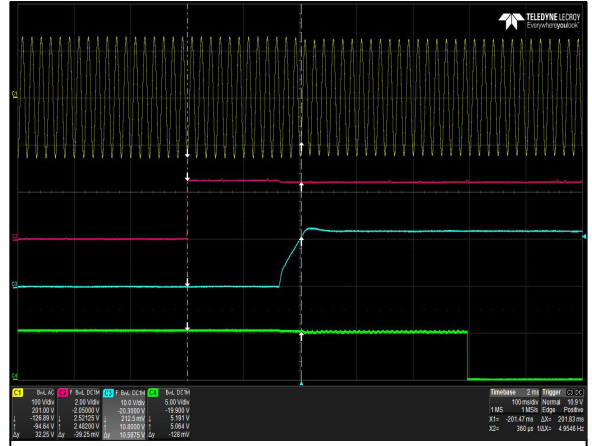

Figure 2: LCM1000L-T Turn-on delay via INH_EN
 Vin = 90Vac Load: lo = 83.3A (12V)
 Ch 1: Vin Ch 2: INH_EN Ch 3: Vo Ch 4: G_DCOK_C

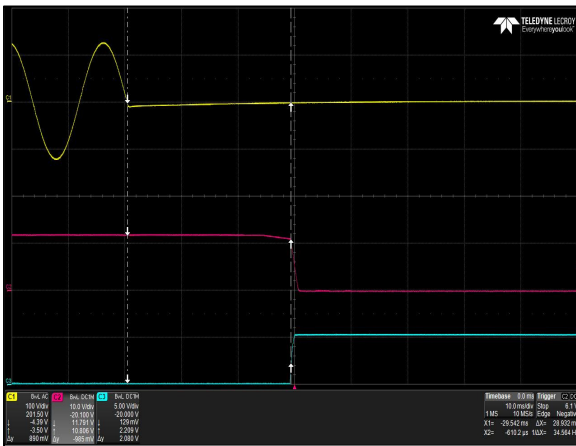

Figure 3: LCM1000L-T Hold-up Time
 Vin = 90Vac / 63Hz / 0° Load: lo = 83.3A (12V)
 Ch 1: Vin Ch 2: Vo Ch 3: G_DCOK_C

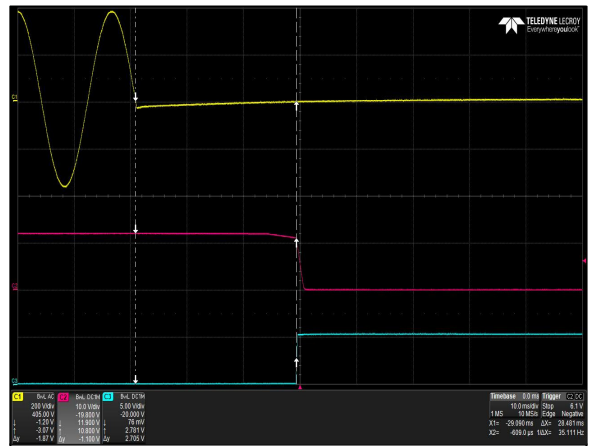

Figure 4: LCM1000L-T Hold-up Time
 Vin = 264Vac / 47Hz / 0° Load: lo = 83.3A (12V)
 Ch 1: Vin Ch 2: Vo Ch 3: G_DCOK_C

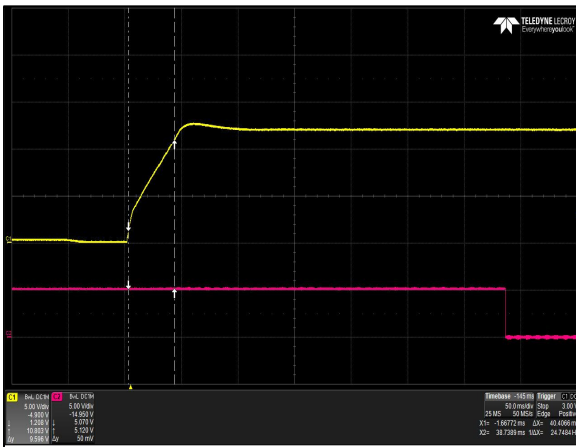

Figure 5: LCM1000L-T Output Voltage Startup Characteristic
 Vin = 90Vac Load: lo = 83.3A (12V)
 Ch 1: Vo Ch 2: G_DCOK_C

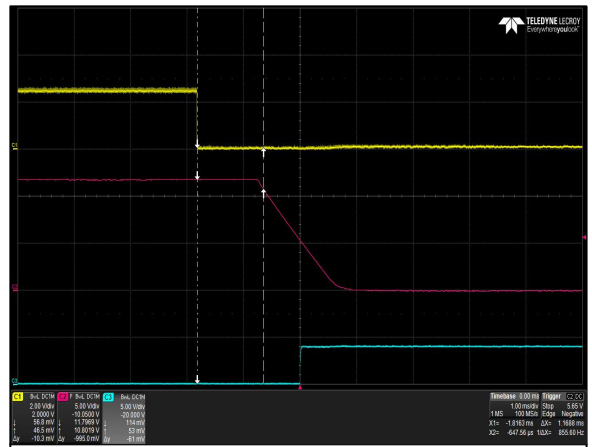

Figure 6: LCM1000L-T Turn Off Characteristic via INH_EN
 Load: lo = 83.3A (12V)
 Ch 1: INH_EN Ch 2: Vo Ch 3: G_DCOK_C

ELECTRICAL SPECIFICATIONS

LCM1000L Performance Curves

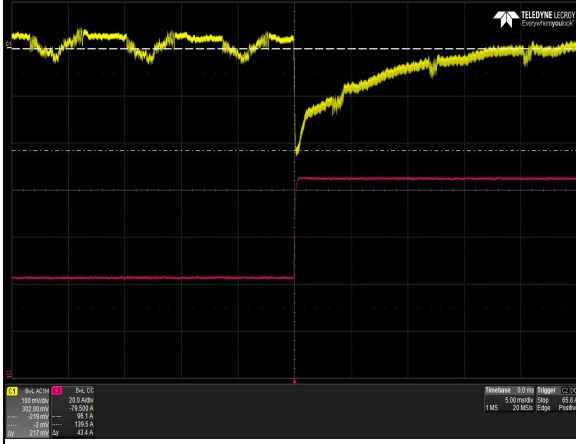

Figure 7: LCM1000L-T Transient Response - Vo Deviation
50% to 100% load change 1A/uS slew rate Vin = 90Vac
Ch 1: Vo Ch 2: Io



Figure 8: LCM1000L-T Transient Response - Vo Deviation
100% to 50% load change 1A/uS slew rate Vin = 90Vac
Ch 1: Vo Ch 2: Io

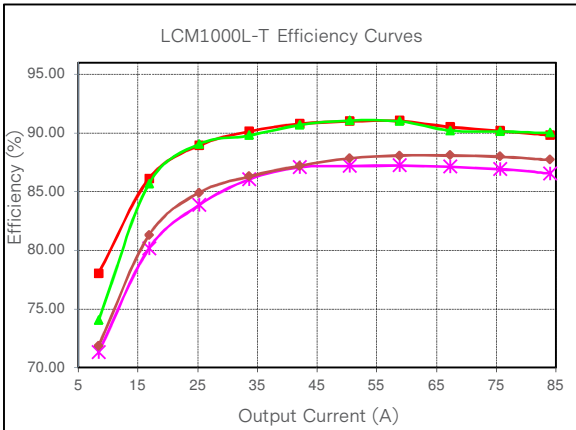

Figure 9: LCM1000L-T Efficiency Curve @ 25°C
— 90Vac — 115Vac — 230Vac — 264Vac
Loading: $I_{o_main} = 10\%I_{o_max}$ increment to 83.3A

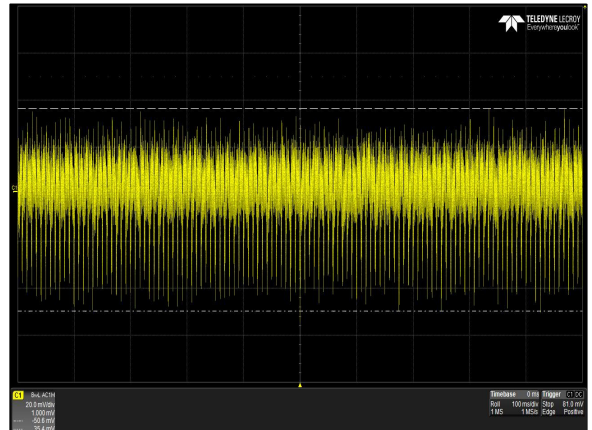

Figure 10: LCM1000L-T Ripple and Noise Measurement
Vin = 90Vac Load: Io = 83.3A (12V)
Ch 1: Vo

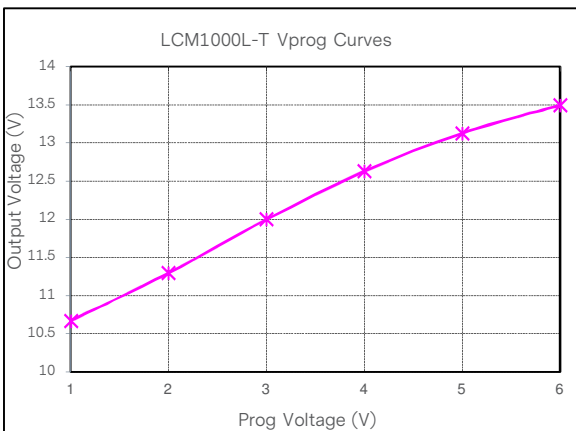

Figure 11: LCM1000L-T Output Voltage Adjustment by Vprog @ 25°C
— 115Vac
Loading: $I_o = 0A$ (12V)

ELECTRICAL SPECIFICATIONS

LCM1000N-T-4 Performance Curves

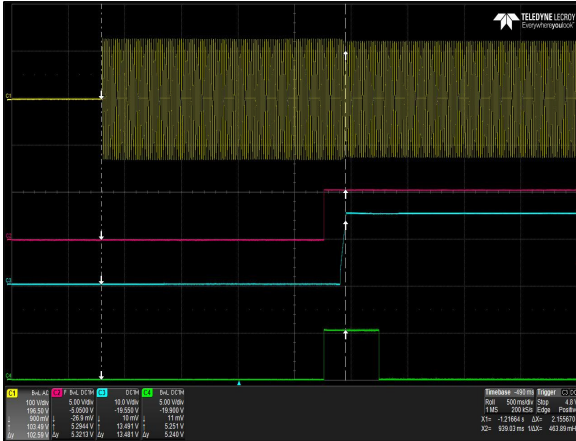

Figure 12: LCM1000N-T-4 Turn-on delay via AC mains
 Vin = 90Vac Load: lo = 66.7A (15V), I_{SB} = 1A (5V)
 Ch 1: Vin Ch 2: Vo Ch 3: G_DCOK_C

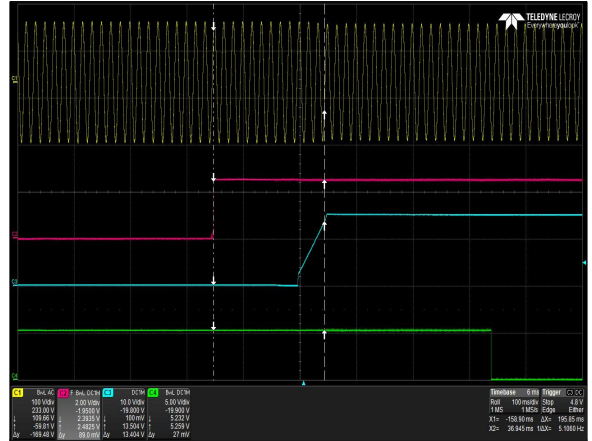

Figure 13: LCM1000N-T-4 Turn-on delay via INH_EN
 Vin = 90Vac Load: lo = 66.7A (15V), I_{SB} = 1A (5V)
 Ch 1: Vin Ch 2: INH_EN Ch 3: Vo Ch 4: G_DCOK_C

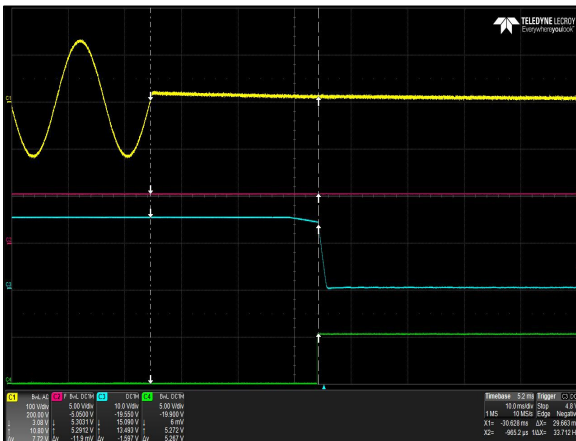

Figure 14: LCM1000N-T-4 Hold-up Time
 Vin = 90Vac / 63Hz / 0° Load: lo = 66.7A (15V), I_{SB} = 1A (5V)
 Ch 1: Vin Ch 2: Vsb Ch 3: Vo Ch 4: G_DCOK_C

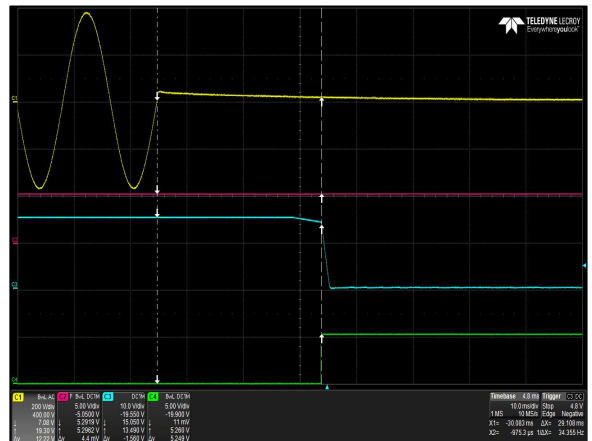

Figure 15: LCM1000N-T-4 Hold-up Time
 Vin = 264Vac / 47Hz / 0° Load: lo = 66.7A (15V), I_{SB} = 1A (5V)
 Ch 1: Vin Ch 2: Vsb Ch 3: Vo Ch 4: G_DCOK_C



Figure 16: LCM1000N-T-4 Output Voltage Startup Characteristic
 Vin = 90Vac Load: lo = 66.7A (15V), I_{SB} = 1A (5V)
 Ch 1: Vo Ch 2: G_DCOK_C

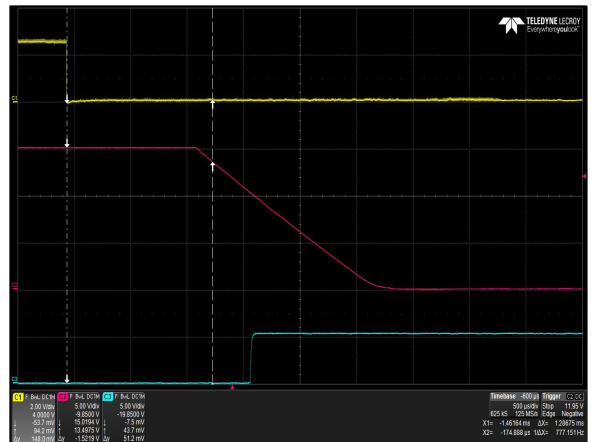

Figure 17: LCM1000N-T-4 Turn Off Characteristic via INH_EN
 Load: lo = 66.7A (15V), I_{SB} = 1A (5V)
 Ch 1: INH_EN Ch 2: Vo Ch 3: G_DCOK_C

ELECTRICAL SPECIFICATIONS

LCM1000N-T-4 Performance Curves

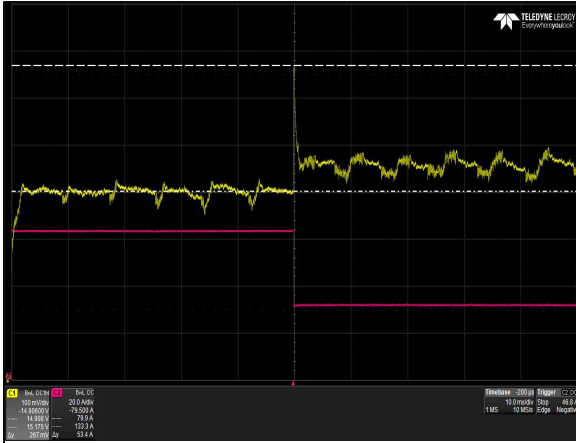

Figure 18: LCM1000N-T-4 Transient Response - Vo Deviation
50% to 100% load change 1A/uS slew rate Vin = 90Vac
Ch 1: Vo Ch 2: Io

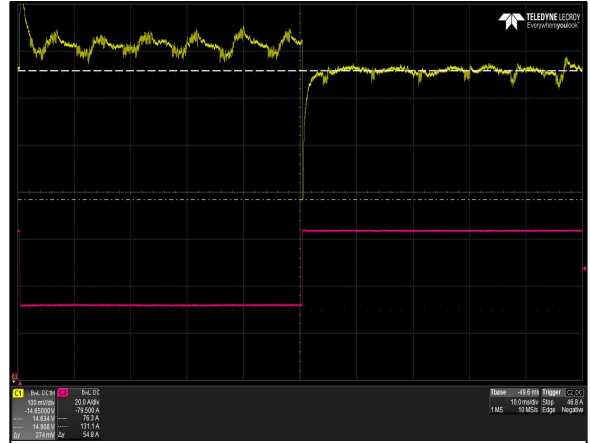

Figure 19: LCM1000N-T-4 Transient Response - Vo Deviation
100% to 50% load change 1A/uS slew rate Vin = 90Vac
Ch 1: Vo Ch 2: Io

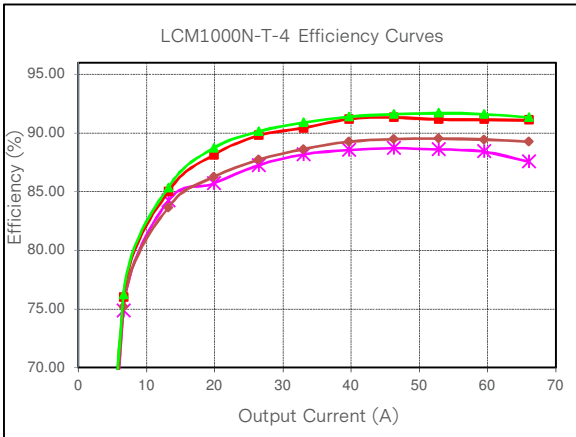

Figure 20: LCM1000N-T-4 Efficiency Curve @ 25°C
— 90Vac — 115Vac — 230Vac — 264Vac
Loading: I_{o_main} = 10%I_{o_max} increment to 66.7A

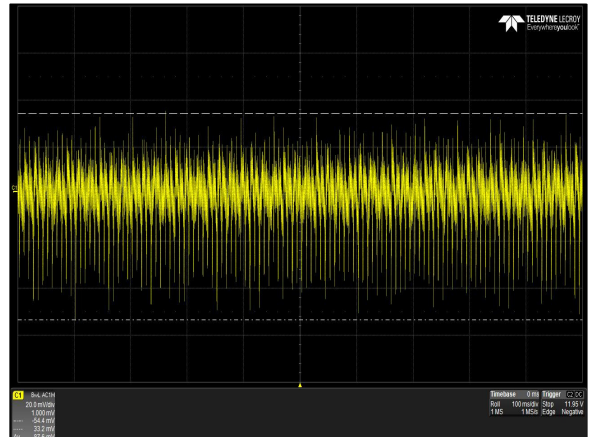

Figure 21: LCM1000N-T-4 Ripple and Noise Measurement
Vin = 90Vac Load: Io = 66.7A (15V)
Ch 1: Vo

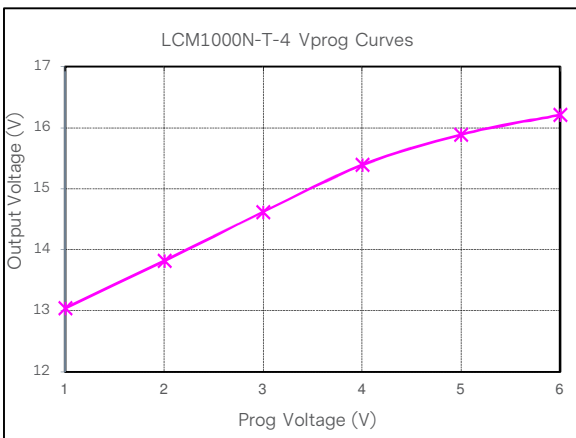

Figure 22: LCM1000N-T-4 Output Voltage Adjustment by Vprog @ 25°C
— 115Vac
Loading: I_o = 0A (15V)

ELECTRICAL SPECIFICATIONS

LCM1000Q-T-4 Performance Curves

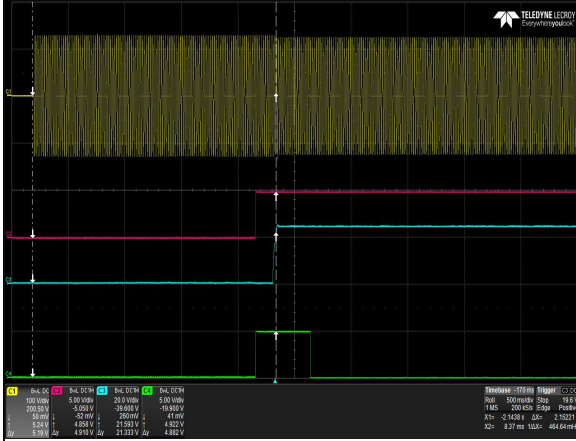

Figure 23: LCM1000Q-T-4 Turn-on delay via AC mains
 Vin = 90Vac Load: lo = 42.0A (24V), I_{SB} = 1A (5V)
 Ch 1: Vin Ch 2: Vo Ch 3: G_DCOK_C

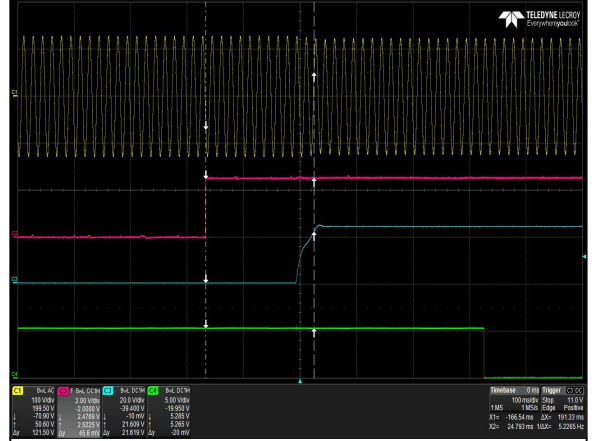

Figure 24: LCM1000Q-T-4 Turn-on delay via INH_EN
 Vin = 90Vac Load: lo = 42.0A (24V), I_{SB} = 1A (5V)
 Ch 1: Vin Ch 2: INH_EN Ch 3: Vo Ch 4: G_DCOK_C

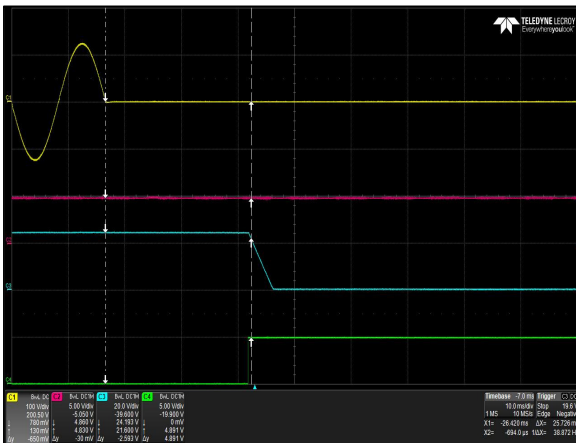

Figure 25: LCM1000Q-T-4 Hold-up Time
 Vin = 90Vac / 63Hz / 0° Load: lo = 42.0A (24V), I_{SB} = 1A (5V)
 Ch 1: Vin Ch 2: Vsb Ch 3: Vo Ch 4: G_DCOK_C

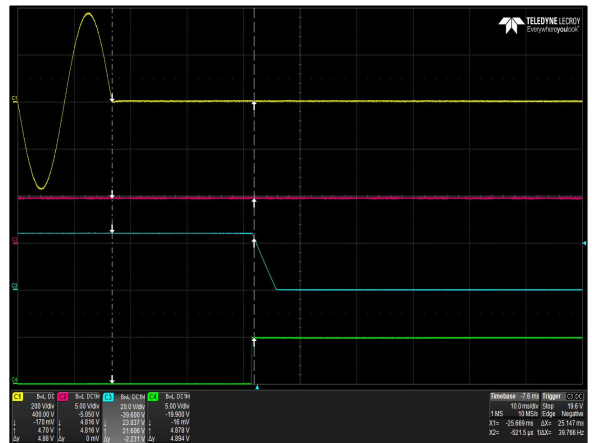

Figure 26: LCM1000Q-T-4 Hold-up Time
 Vin = 264Vac / 47Hz / 0° Load: lo = 42.0A (24V), I_{SB} = 1A (5V)
 Ch 1: Vin Ch 2: Vsb Ch 3: Vo Ch 4: G_DCOK_C

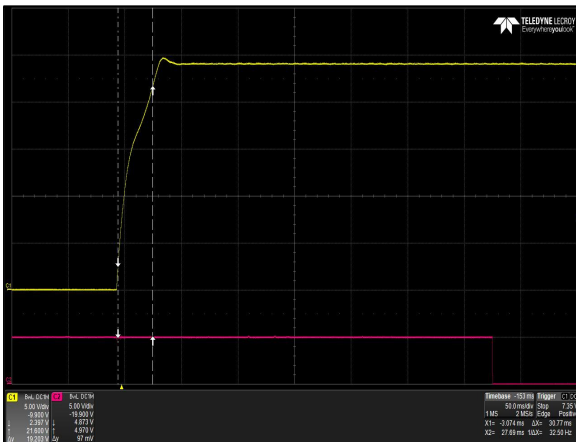

Figure 27: LCM1000Q-T-4 Output Voltage Startup Characteristic
 Vin = 90Vac Load: lo = 42.0A (24V), I_{SB} = 1A (5V)
 Ch 1: Vo Ch 2: G_DCOK_C

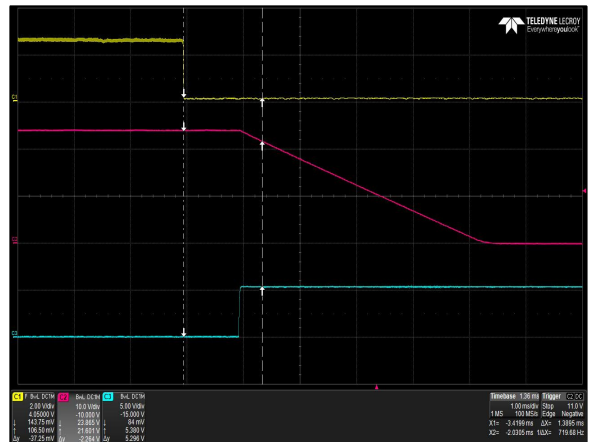

Figure 28: LCM1000Q-T-4 Turn Off Characteristic via INH_EN
 Load: lo = 42.0A (24V), I_{SB} = 1A (5V)
 Ch 1: INH_EN Ch 2: Vo Ch 3: G_DCOK_C

ELECTRICAL SPECIFICATIONS

LCM1000Q-T-4 Performance Curves

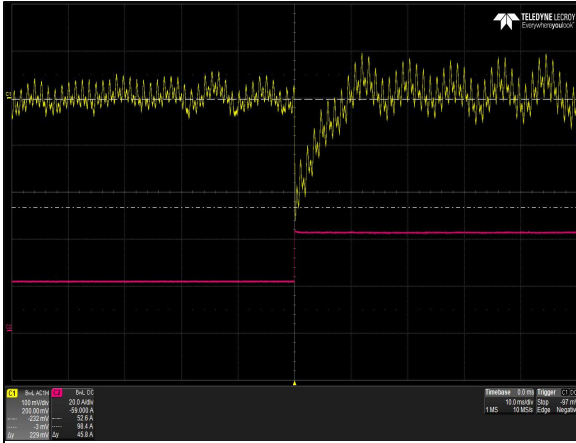

Figure 29: LCM1000Q-T-4 Transient Response - Vo Deviation
50% to 100% load change 1A/uS slew rate Vin = 90Vac
Ch 1: Vo Ch 2: Io

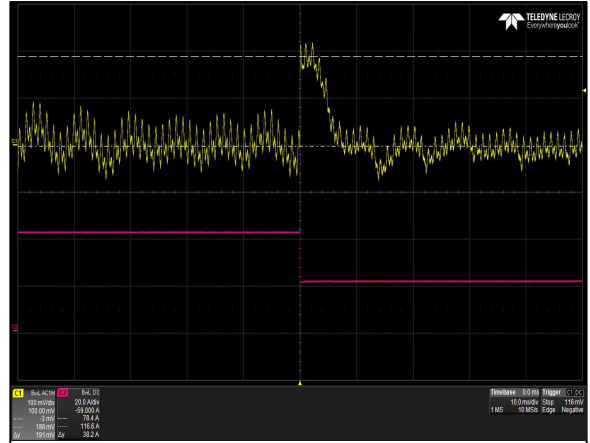

Figure 30: LCM1000Q-T-4 Transient Response - Vo Deviation
100% to 50% load change 1A/uS slew rate Vin = 90Vac
Ch 1: Vo Ch 2: Io

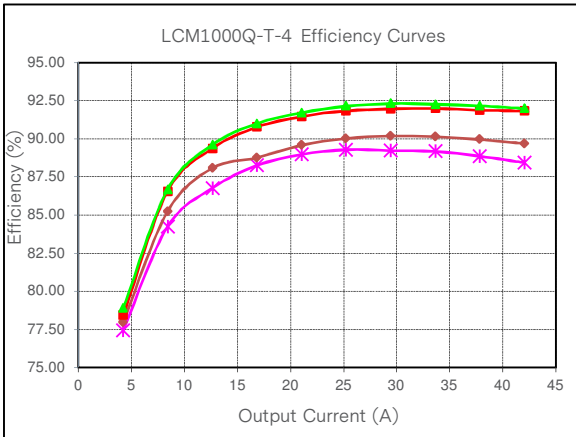

Figure 31: LCM1000Q-T-4 Efficiency Curve @ 25°C
Loading: $I_{o_main} = 10\% I_{o_max}$ increment to 42.0A

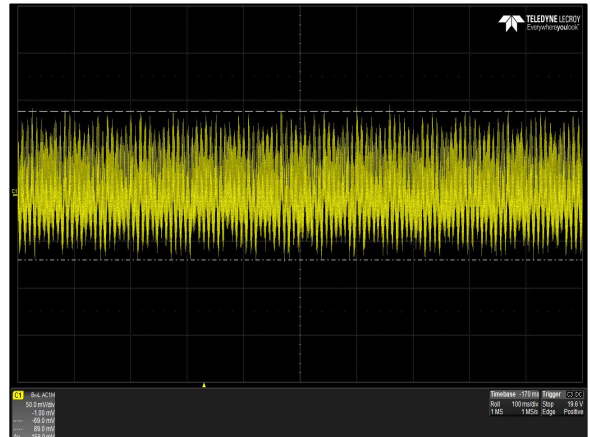

Figure 32: LCM1000Q-T-4 Ripple and Noise Measurement
Vin = 90Vac Load: Io = 42.0A (24V)
Ch 1: Vo

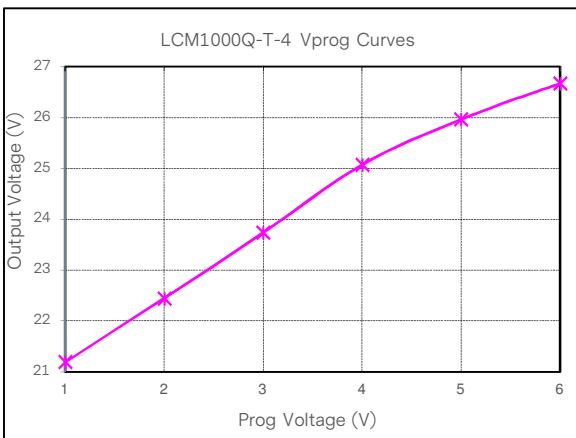

Figure 33: LCM1000Q-T-4 Output Voltage Adjustment by Vprog @ 25°C
Loading: $I_o = 0A$ (24V)

ELECTRICAL SPECIFICATIONS

LCM1000U-T-4 Performance Curves

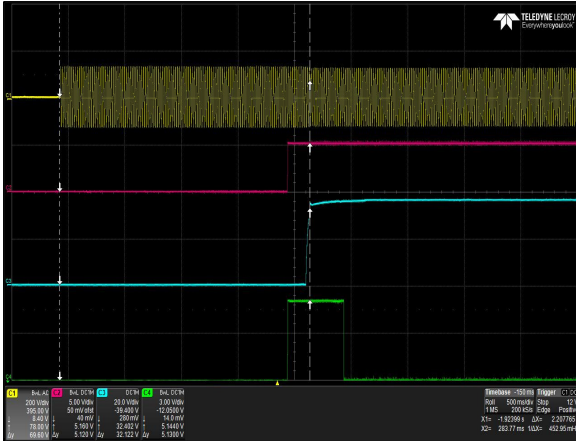

Figure 34: LCM1000U-T-4 Turn-on delay via AC mains
 Vin = 90Vac Load: lo = 27.8A (36V), I_{SB} = 1A (5V)
 Ch 1: Vin Ch 2: Vo Ch 3: G_DCOK_C

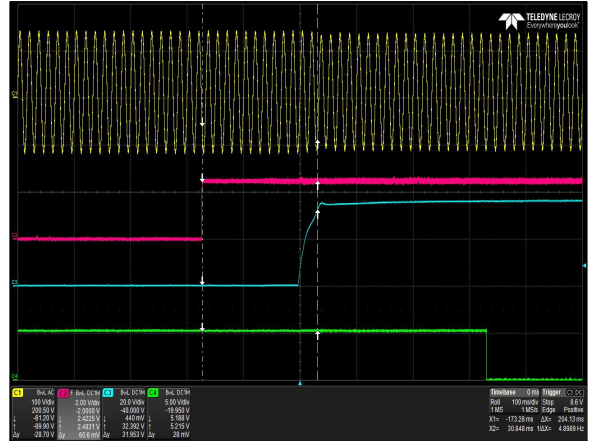

Figure 35: LCM1000U-T-4 Turn-on delay via INH_EN
 Vin = 90Vac Load: lo = 27.8A (36V), I_{SB} = 1A (5V)
 Ch 1: Vin Ch 2: INH_EN Ch 3: Vo Ch 4: G_DCOK_C

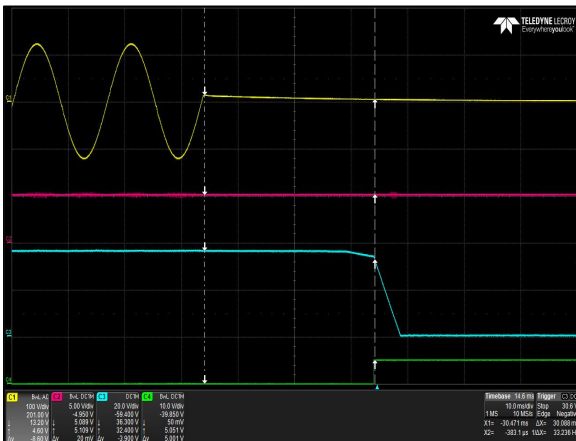

Figure 36: LCM1000U-T-4 Hold-up Time
 Vin = 90Vac / 63Hz / 0° Load: lo = 27.8A (36V), I_{SB} = 1A (5V)
 Ch 1: Vin Ch 2: Vsb Ch 3: Vo Ch 4: G_DCOK_C

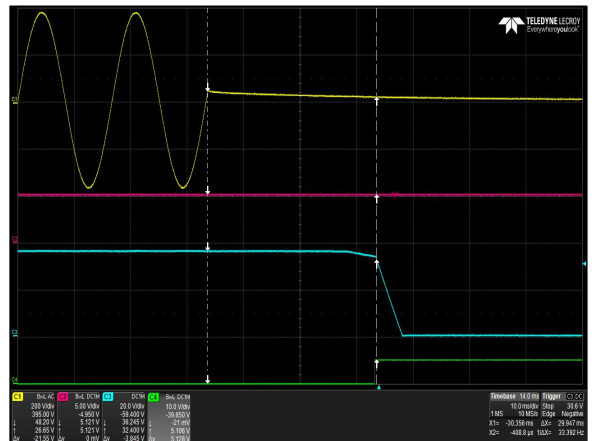

Figure 37: LCM1000U-T-4 Hold-up Time
 Vin = 264Vac / 47Hz / 0° Load: lo = 27.8A (36V), I_{SB} = 1A (5V)
 Ch 1: Vin Ch 2: Vsb Ch 3: Vo Ch 4: G_DCOK_C

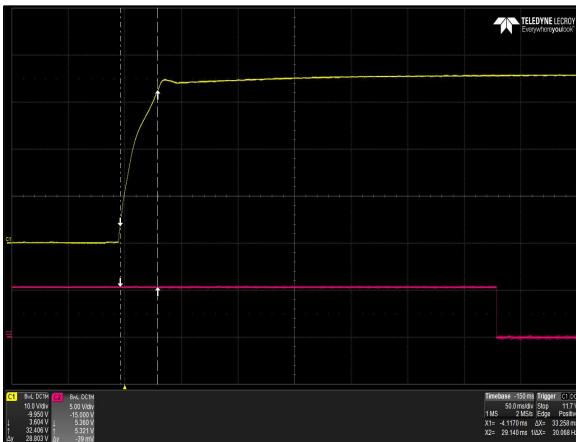

Figure 38: LCM1000U-T-4 Output Voltage Startup Characteristic
 Vin = 90Vac Load: lo = 27.8A (36V), I_{SB} = 1A (5V)
 Ch 1: Vo Ch 2: G_DCOK_C

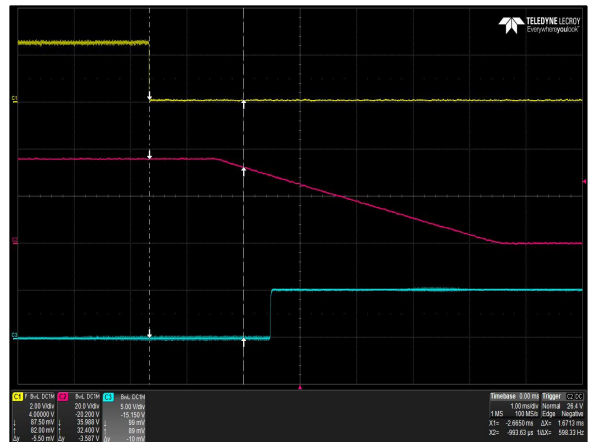

Figure 39: LCM1000U-T-4 Turn Off Characteristic via INH_EN
 Load: lo = 27.8A (36V), I_{SB} = 1A (5V)
 Ch 1: INH_EN Ch 2: Vo Ch 3: G_DCOK_C

ELECTRICAL SPECIFICATIONS

LCM1000U-T-4 Performance Curves

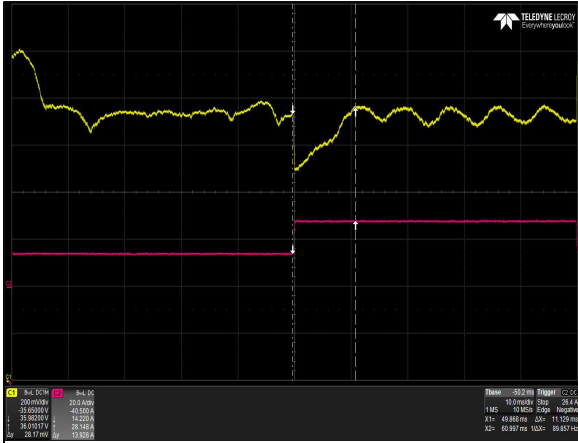

Figure 40: LCM1000U-T-4 Transient Response - Vo Deviation
 50% to 100% load change 1A/uS slew rate Vin = 90Vac
 Ch 1: Vo Ch 2: Io

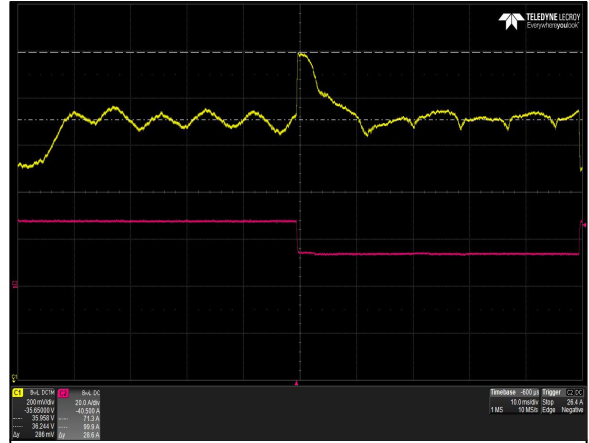

Figure 41: LCM1000U-T-4 Transient Response - Vo Deviation
 100% to 50% load change 1A/uS slew rate Vin = 90Vac
 Ch 1: Vo Ch 2: Io

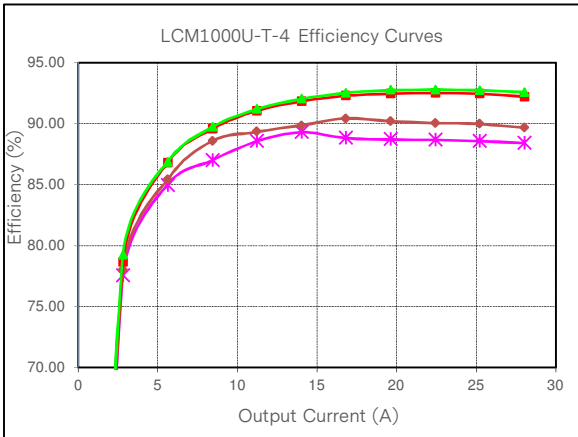

Figure 42: LCM1000U-T-4 Efficiency Curve @ 25°C
 Loading: I_{o,main} = 10%I_{o,max} increment to 27.8A

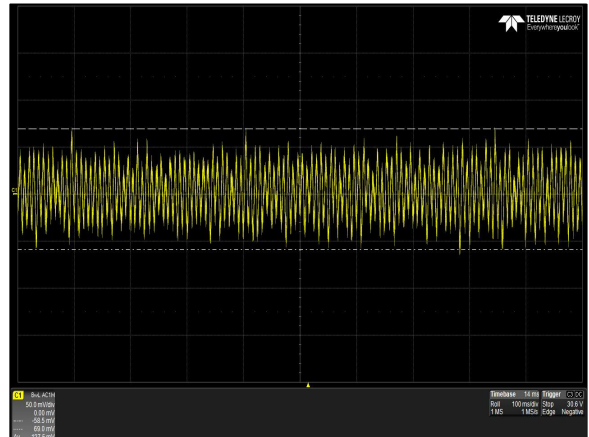

Figure 43: LCM1000U-T-4 Ripple and Noise Measurement
 Vin = 90Vac Load: Io = 27.8A (36V)
 Ch 1: Vo

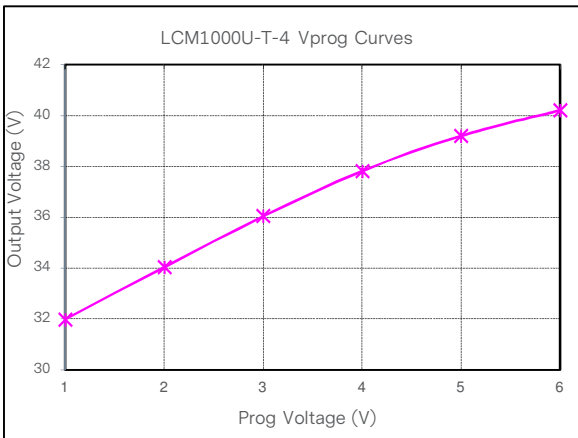

Figure 44: LCM1000U-T-4 Output Voltage Adjustment by Vprog @ 25°C
 Loading: I_o = 0A (36V)

ELECTRICAL SPECIFICATIONS

LCM1000W-T-4 Performance Curves

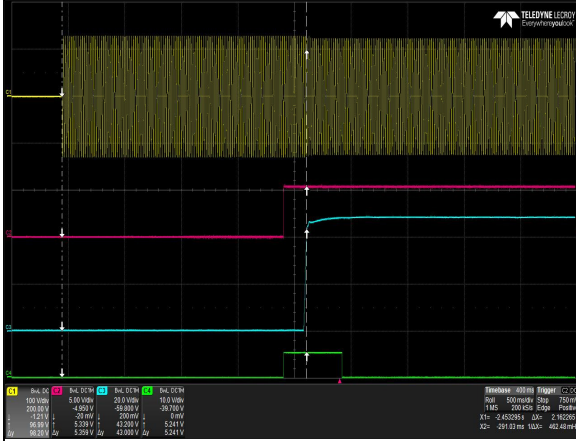

Figure 45: LCM1000W-T-4 Turn-on delay via AC mains
 Vin = 90Vac Load: lo = 20.8A (48V), I_{SB} = 1A (5V)
 Ch 1: Vin Ch 2: Vo Ch 3: G_DCOK_C

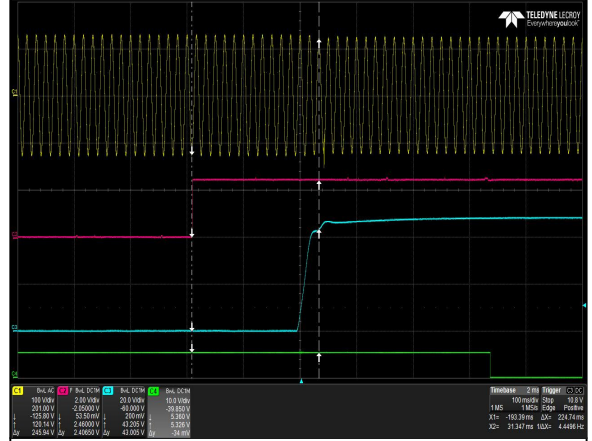

Figure 46: LCM1000W-T-4 Turn-on delay via INH_EN
 Vin = 90Vac Load: lo = 20.8A (48V), I_{SB} = 1A (5V)
 Ch 1: Vin Ch 2: INH_EN Ch 3: Vo Ch 4: G_DCOK_C

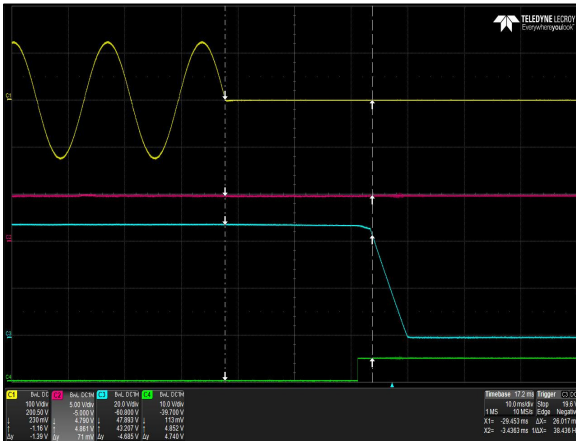

Figure 47: LCM1000W-T-4 Hold-up Time
 Vin = 90Vac / 63Hz / 0° Load: lo = 20.8A (48V), I_{SB} = 1A (5V)
 Ch 1: Vin Ch 2: Vsb Ch 3: Vo Ch 4: G_DCOK_C

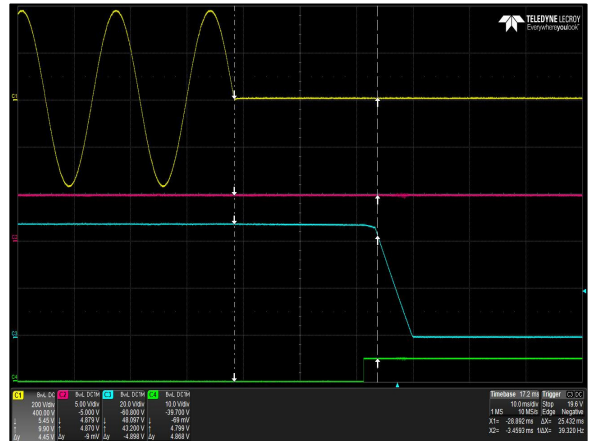

Figure 48: LCM1000W-T-4 Hold-up Time
 Vin = 264Vac / 47Hz / 0° Load: lo = 20.8A (48V), I_{SB} = 1A (5V)
 Ch 1: Vin Ch 2: Vsb Ch 3: Vo Ch 4: G_DCOK_C

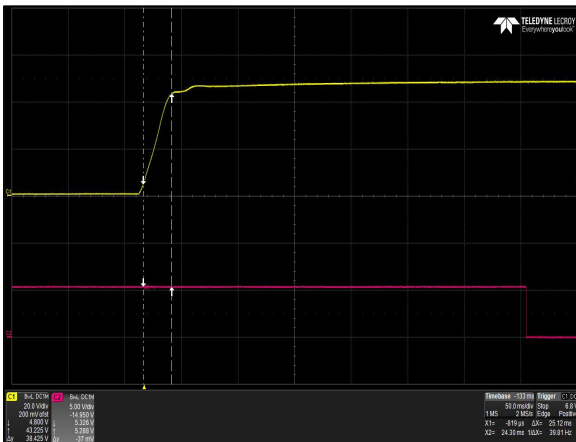

Figure 49: LCM1000W-T-4 Output Voltage Startup Characteristic
 Vin = 90Vac Load: lo = 20.8A (48V), I_{SB} = 1A (5V)
 Ch 1: Vo Ch 2: G_DCOK_C

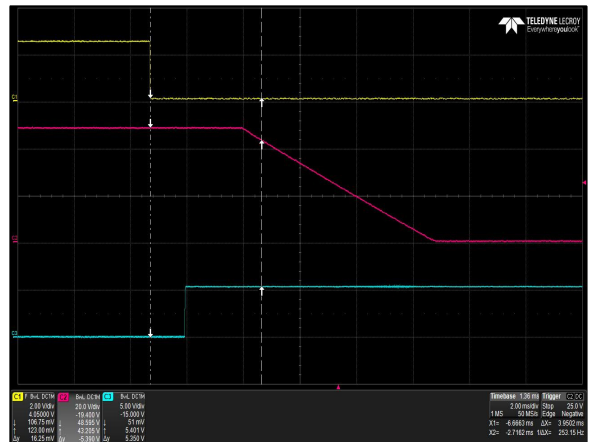

Figure 50: LCM1000W-T-4 Turn Off Characteristic via INH_EN
 Load: lo = 20.8A (48V), I_{SB} = 1A (5V)
 Ch 1: INH_EN Ch 2: Vo Ch 3: G_DCOK_C

ELECTRICAL SPECIFICATIONS

LCM1000W-T-4 Performance Curves

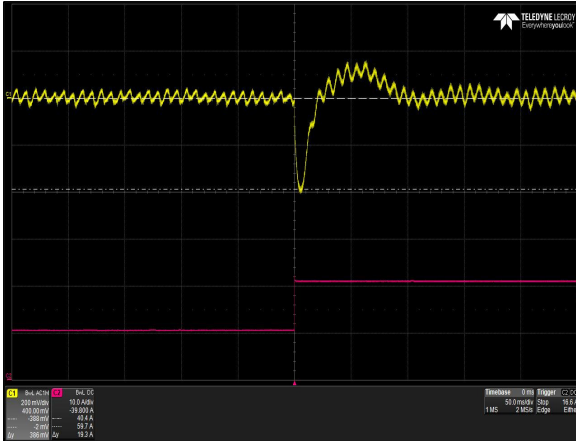

Figure 51: LCM1000W-T-4 Transient Response - Vo Deviation
 50% to 100% load change 1A/uS slew rate Vin = 90Vac
 Ch 1: Vo Ch 2: Io

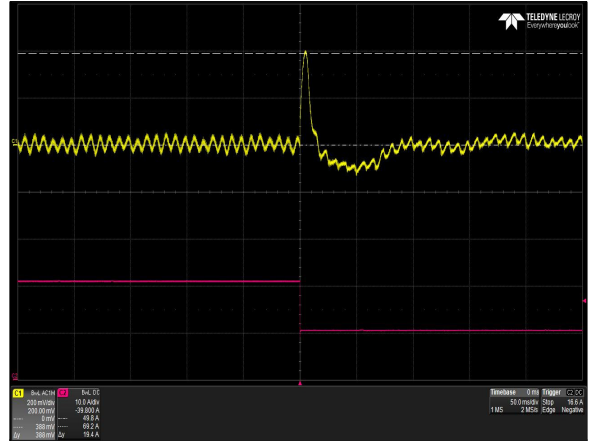

Figure 52: LCM1000W-T-4 Transient Response - Vo Deviation
 100% to 50% load change 1A/uS slew rate Vin = 90Vac
 Ch 1: Vo Ch 2: Io

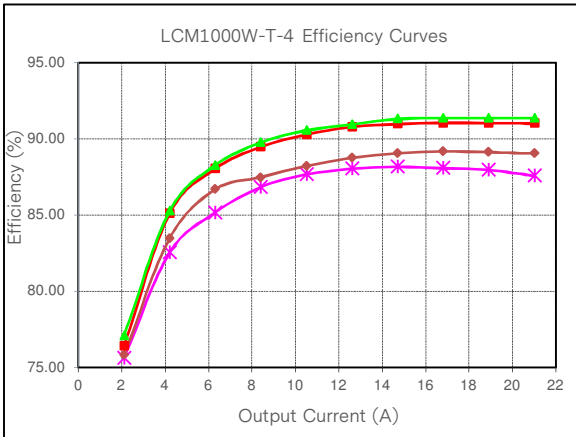

Figure 53: LCM1000W-T-4 Efficiency Curve @ 25°C
 Loading: I_{o,main} = 10%I_{o,max} increment to 20.8A

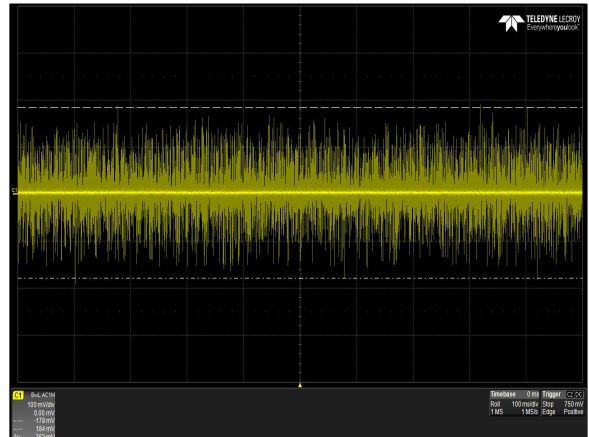

Figure 54: LCM1000W-T-4 Ripple and Noise Measurement
 Vin = 90Vac Load: Io = 20.8A (48V)
 Ch 1: Vo

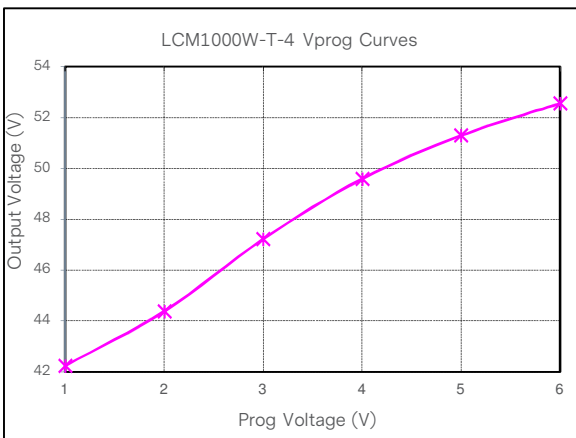

Figure 55: LCM1000W-T-4 Output Voltage Adjustment by Vprog @25°C
 Loading: I_o = 0A (48V)

ELECTRICAL SPECIFICATIONS

Protection Function Specifications

Input Fuse

LCM1000 series is equipped with an internal non user serviceable 30A high rupturing capacity (HRC) 250 Vac fuse to IEC 127 for fault protection in both the L1 and L2 lines input.

Over Voltage Protection (OVP)

The power supply latches off during output overvoltage protected. The OVP trip level is 125%~145% of the nominal main output voltage setting and 110%~125% of the nominal standby output voltage setting. When the OVP circuit is activated, the power supply requires the input power been recycled to remove the fault condition.

Parameter	Min	Typ	Max	Unit
V _O Output Overvoltage	125	/	145	% V _O
Standby Voltage Overvoltage	110	/	125	% V _{SB}

Over Current Protection (OCP)

The power supply output will be in automatic mode with a recovery time delay of 20 Sec when the output current hits the OCP limit provided. Over current fault on the standby output will also turn off the Main output.

Parameter	Min	Typ	Max	Unit
V _O Output Overcurrent	105	/	125	% I _{O,max}
Standby Voltage Overcurrent	120	/	170	% I _{SB,max}

Short Circuit Protection (SCP)

A short circuit is defined as less than 0.03 ohm resistance between the output terminals. All outputs will be protected against short circuit to ground or other outputs. No damage will result. In the event of short circuit, LCM1000 series power supply will be in bouncing mode with a recovery delay of 20 Sec.

Optional 5V standby, independent of the main output, will also be in bouncing mode once the fault occurred.

Over Temperature Protection (OTP)

The power supply will be internally protected against over temperature conditions. When the OTP circuit is activated, the power supply will shut off and will auto-recover once the over temperature condition is gone. OTP trip-point at full Load is set at a nominal of 55 °C to 65 °C ambient temperature.

MECHANICAL SPECIFICATIONS

Mechanical Outlines (unit:mm)

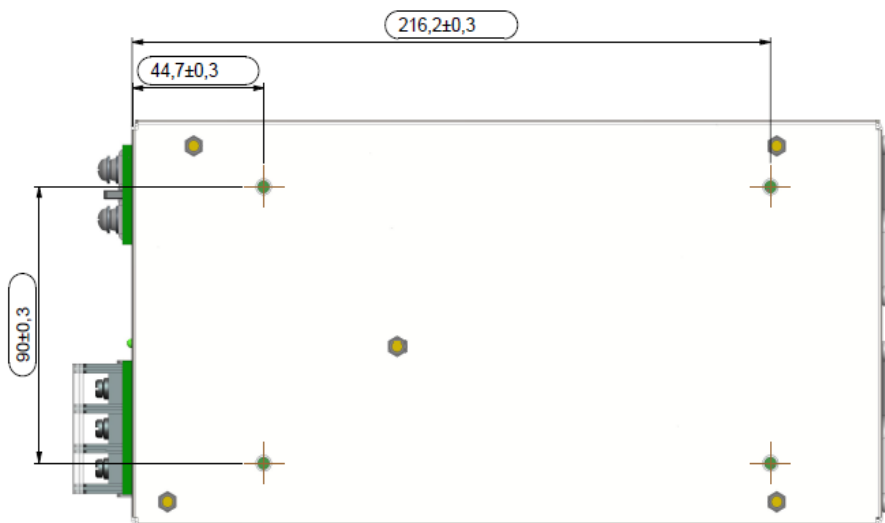
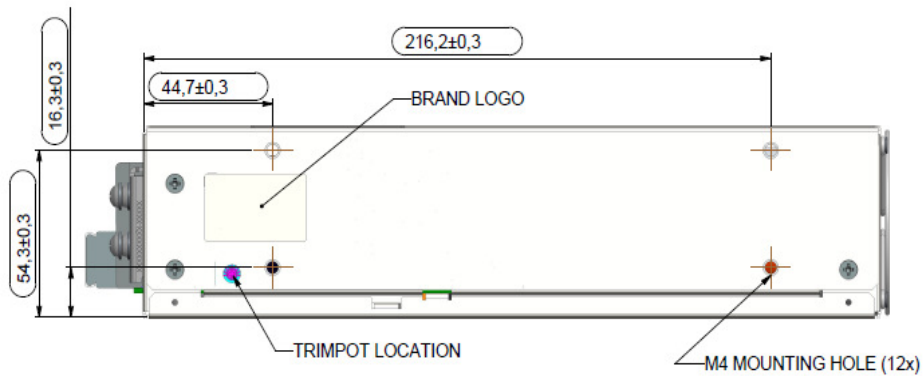
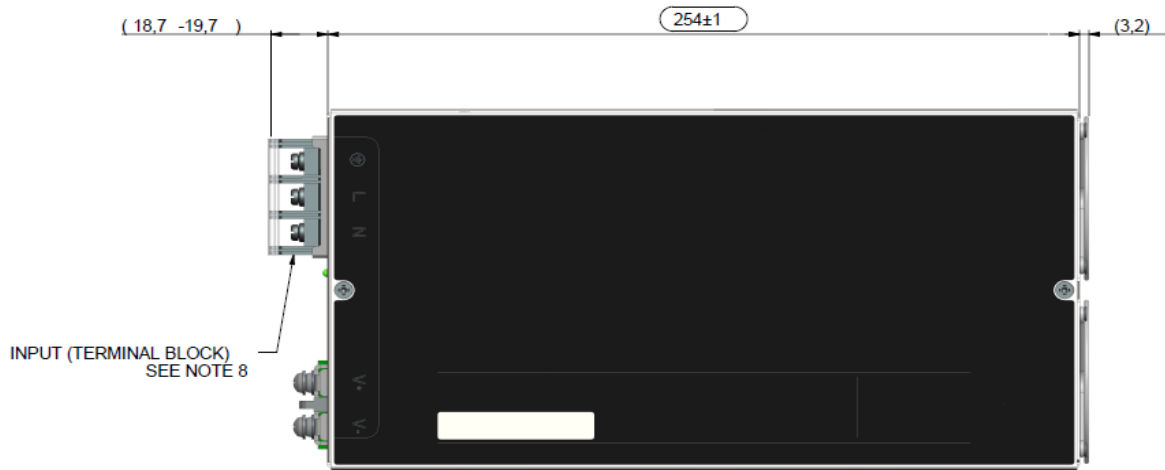

MECHANICAL SPECIFICATIONS

Mechanical Outlines (unit:mm)

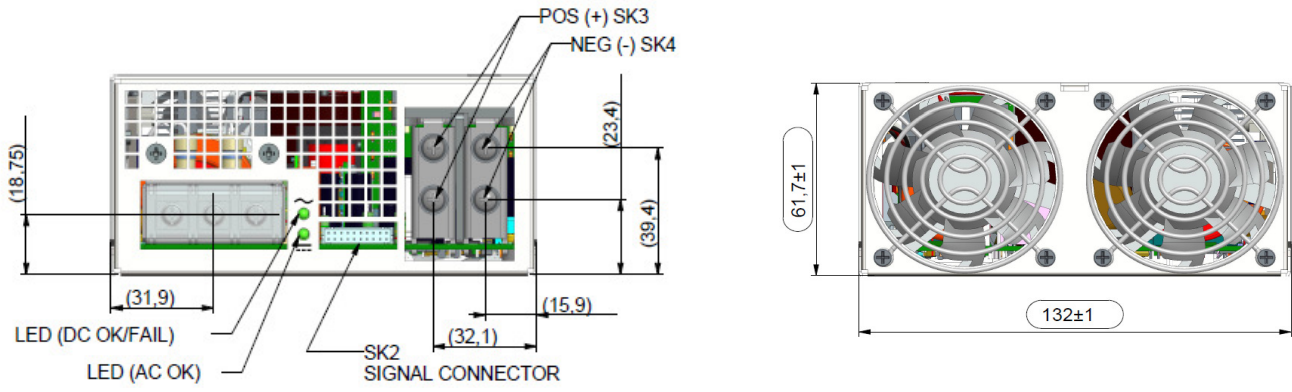

MECHANICAL SPECIFICATIONS

Mechanical Outlines - Voltage Adjustment Pot Location

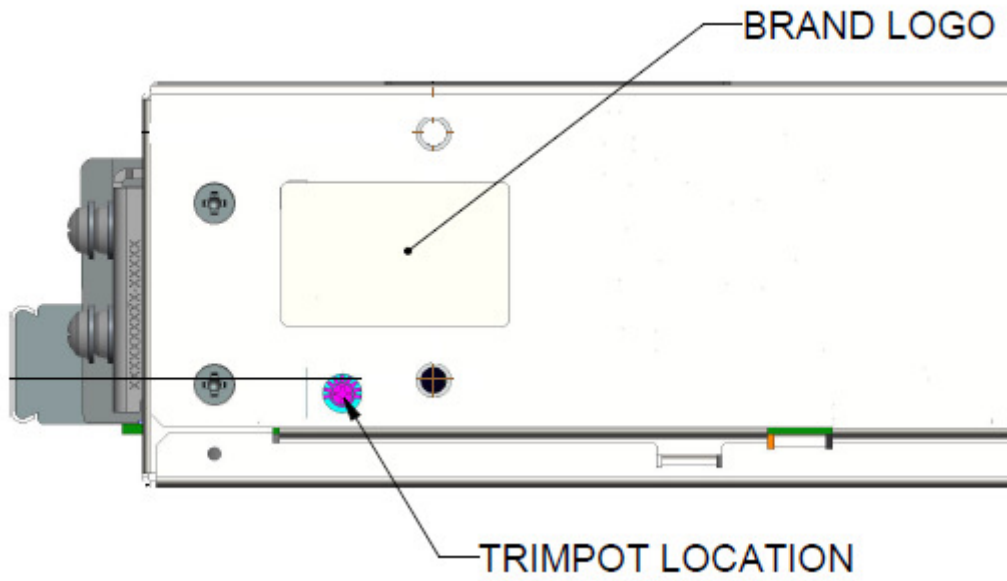

MECHANICAL SPECIFICATIONS

Connector Definitions

AC Input Connector - SK1

⊕ – Earth Ground

L – Line

N – Neutral

Output Connector – SK3&SK4

SK3 – +Vout

SK4 – GND

Output Connector – SK2

Pin 1 – A2

Pin 2 – -VPROG

Pin 3 – A1

Pin 4 – -VSense

Pin 5 – ISHARE

Pin 6 – A0

Pin 7 – SDA1

Pin 8 – +VPROG

Pin 9 – SCL1

Pin 10 – +Vsense

Pin 11 – 5VSB

Pin 12 – GND

Pin 13 – 5VSB

Pin 14 – G_DCOK_C

Pin 15 – N/A

Pin 16 – G_DCOK_E

Pin 17 – GND

Pin 18 – G_ACOK_C

Pin 19 – INH_EN

Pin 20 – G_ACOK_E

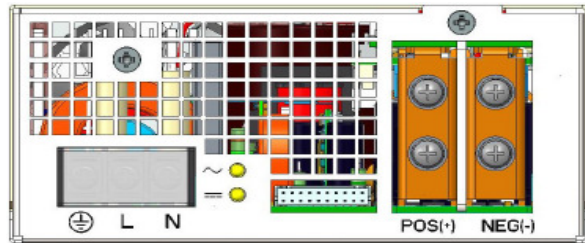

SK1

SK2

SK3

SK4

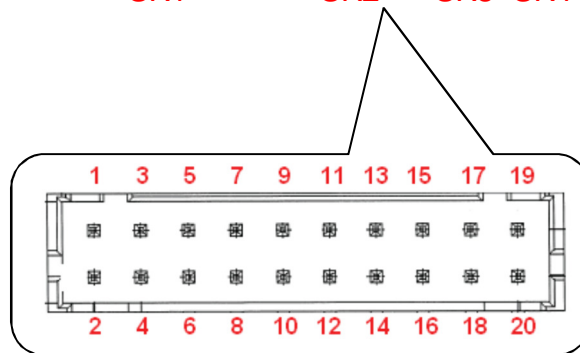

MECHANICAL SPECIFICATIONS

Power / Signal Mating Connectors and Pin Types

Table 5. Mating Connectors for LCM1000 Series		
Reference	On Power Supply	Mating Connector or Equivalent
SK1 - AC Input Connector	451-004155-0000(TERM-BLOCK DT-7C-B14W-03)	M4 Screw
SK2 - Signal Connector	CI0120P1HD0-LF	LANLANDWIN (LWE PN: 2050S) Housing (LWE PN: 2053T) Contact CVILUX (CX PN: CI0120SD000) Housing (CX PN: CI01TD21PE0) Contact
SK3, SK4 - Output Connector	For LCM1000Q/U/W 500-004305-0000 For LCM1000L/N 500-007008-0001	For LCM1000Q/U/W Molex: BB-124-08 (19141-0058) M4 Screw For LCM1000L/N Clearance hole diameter $\phi 8.5$

Accessories for SK2:

1. Order kit part number 73-788-001 for control connector interface with .3m wires attached

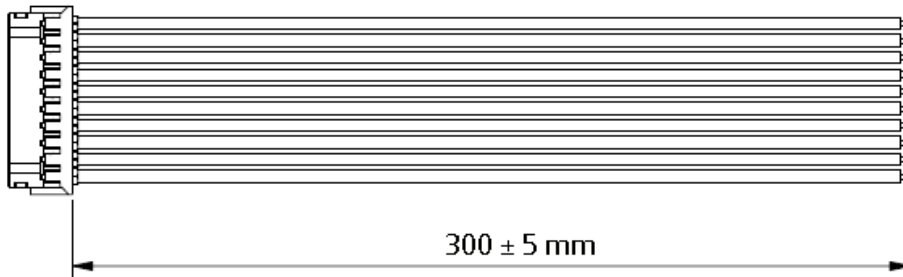

2. Order kit part number 73-788-002 for control connector interface with unloaded housing and 20 pins

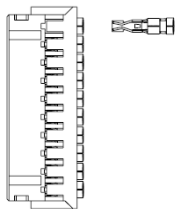

MECHANICAL SPECIFICATIONS

LED Indicator Definitions

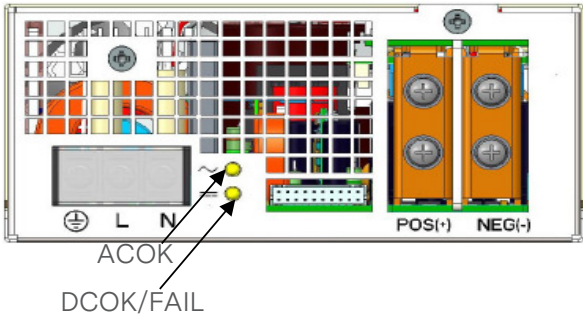

Two user-friendly LEDs for status and diagnostics show status of input power, output power and alarm condition valuable troubleshooting aid to reduce system downtime.

Conditions	LED Status	
	ACOK LED	DCOK/FAIL LED
AC present / Output On	Green	Green
No AC power to PSU	OFF	OFF
Standby mode/main output off	Green	OFF
Power supply failure	Green	OFF

MECHANICAL SPECIFICATIONS

Weight

The LCM1000 series power supply typical weight is 4.354lbs (1.975kg).

ENVIRONMENTAL SPECIFICATIONS

EMC Immunity

The LCM1000 series are designed to meet the following EMC immunity specifications

Table 6. Environmental Specifications	
Document	Description
EMC Emission:	
EN55022	Conducted and radiated EMI limits specified in FCC Docket No. 20780 Part 15 Subpart J Class A and the limits specified in EN55022, Level A with a minimum of 6dB margin under the limits.
EN61000-3-2	EMC limits for harmonic current emissions
EMC Immunity:	
EN61000-4-2	ESD: +/-8KV air, +/-15kV contact discharge, Level 3
EN61000-4-3	Conducted Susceptibility: 0.15 - 80 MHz, 10V/m, AM 80% (1KHz), Level 3 – designed to meet
EN61000-4-4	Fast Transient: 2KV for AC power port, 1.0 KV for DC power, I/O and signal ports, Level 3
EN61000-4-5	Surges: 2KV common mode and 1KV differential mode for AC power ports and 0.5 KV differential mode for DC power, I/O and signal ports, Level 3
EN61000-4-8	Power Frequency Magnetic, Level 3
EN61000-4-11	Voltage Dips and Interruptions: 30% reduction for 500 mS – Criteria B, >95% reduction for 10 mS, Criteria A, >95% reduction for 5000 mS, Level 3
EN55024: 1998	Information Technology Equipment – Immunity Characteristics, Limits and Method of Measurement
General Protection Safety:	
IEC60950-1	SELV

ENVIRONMENTAL SPECIFICATIONS

Safety Certifications

The LCM1000 series are intended for inclusion in other equipment and the installer must ensure that it is in compliance with all the requirements of the end application. This product is only for inclusion by professional installers within other equipment and must not be operated as a standard alone product.

Table 7. Safety Certifications for LCM1000 Series Power Supply System		
Standard	File#	Description
UL 60950-1 2 nd Edition/ CSA C22.2 No. 60950-1-07, 2nd Edition	E186249-A270-UL-X6	US and Canada Requirements
UL ANSI/AAMI ES60601-1 (2005 + C1:09 + A2:10 + A1:12), CAN/CSA-C22.2 No. 60601-1	E182560-V4-S5	US and Canada Medical Electrical Equipment
UL ANSI/AAMI ES60601-1 (2005 + C1:09 + A2:10, CAN/CSA-C22.2 No. 60601-1 (2008)	E182560-A37-UL-X1	US and Canada Medical Electrical Equipment
TUV EN60950-1	Z2 16 05 13890 02685	European Requirements
IEC60950-1/EN60950	E186249-A270-CB-2	International Requirements
IEC60601	SG-MD-00487A1/M2	International Medical Electrical Equipment
IEC60601-1/EN60601-1	211-400848-201	European and International Electrical Equipment
CB Certificate and Report	DK-48584-A2-UL	(All CENELEC Countries)
CE (LVD+RoHS),EN60950-1	16352	European Requirements
CCC (UL)	2014010907712741	China Requirements
CCC PoP	FZ1501048980	China Requirements
IEC 62368-1:2014	DK-92417-UL	International Requirements
UL 62368-1, 2nd Ed, 2014-12-01, CAN/CSA C22.2 No. 62368-1-14, 2nd Ed	E186249-A6046-UL-X10	US and Canada Requirements
EN62368-1:2014 /A11:2017, EN 60601-1:2006/A1:2013	B 013890 3163 Rev. 00	European Requirements
UKCA Mark		UK Requirements

ENVIRONMENTAL SPECIFICATIONS

EMI Emissions

The LCM1000 series power supply has been designed to comply with the Class A limits of EMI requirements of EN55022 (FCC Part 15) for emissions and relevant sections of EN61000 (IEC 61000) for immunity. The unit is enclosed inside a metal box, tested at 1000W using resistive load with cooling fan.

Conducted Emissions

The applicable standard for conducted emissions is EN55022 (FCC Part 15). Conducted noise can appear as both differential mode and common mode noise currents. Differential mode noise is measured between the two input lines, with the major components occurring at the supply fundamental switching frequency and its harmonics. Common mode noise, a contributor to both radiated emissions and input conducted emissions, is measured between the input lines and system ground and can be broadband in nature.

Parameter	Model	Symbol	Min	Typ	Max	Unit
FCC Part 15, class A	All	Margin	6	-	-	dB

Radiated Emissions

Unlike conducted EMI, radiated EMI performance in a system environment may differ drastically from that in a stand-alone power supply. The shielding effect provided by the system enclosure may bring the EMI level from Class A to Class B. It is thus recommended that radiated EMI be evaluated in a system environment. The applicable standard is EN55022 Class A (FCC Part 15). Testing ac-dc convertors as a stand-alone component to the exact requirements of EN55022 can be difficult, because the standard calls for 1m leads to be attached to the input and outputs and aligned such as to maximize the disturbance. In such a set-up, it is possible to form a perfect dipole antenna that very few ac-dc convertors could pass. However, the standard also states that an attempt should be made to maximize the disturbance consistent with the typical application by varying the configuration of the test sample.

ENVIRONMENTAL SPECIFICATIONS

Operating Temperature

The LCM1000 series power supply maximum output power (1000W) can be loaded up to an ambient temperature of +50 °C . Only 50% (500W) of the maximum output power can be loaded at ambient temperature of +70 °C. Linear derating to 50% nominal output power starts from +50 °C. The elapsed time between the application of input power and the attainment steady state values requires 5 minute warm up for -20 °C to -40 °C operation.

Output power vs operating temperature

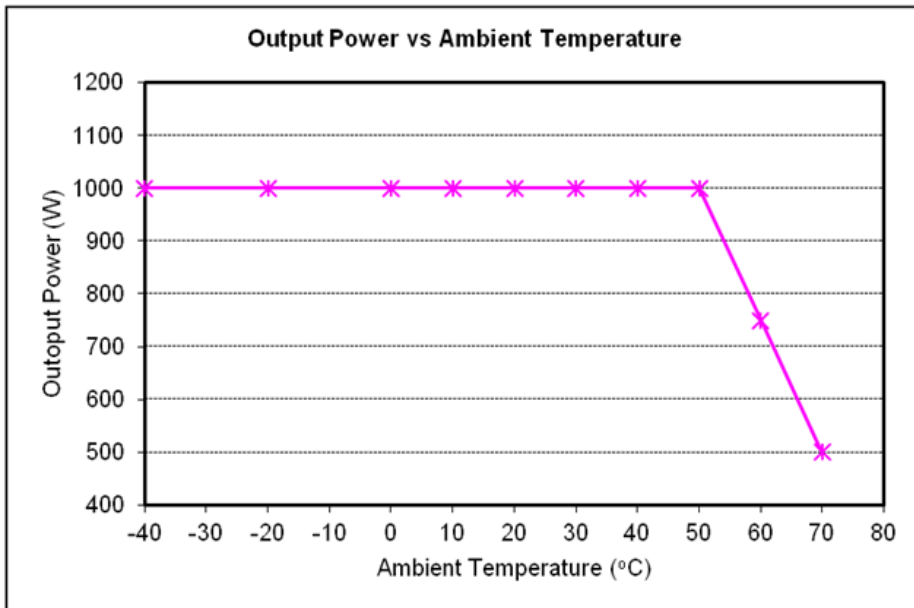

Forced Air Cooling

The LCM1000 series power supply includes internal cooling fans as part of the power supply assembly to provide forced air-cooling to maintain and control temperature of devices and ambient. The standard direction of airflow is from the end of the power supply. The cooling fan is a variable speed fan. Fan will be smart based on internal temperature. Fan noise <45 dB with 80% load @ 30 °C.

ENVIRONMENTAL SPECIFICATIONS

Storage and Shipping Temperature

The LCM1000 series power supply can be stored or shipped at temperatures between -40 °C to +85 °C and relative humidity from 10% to 95% non-condensing.

Altitude

The LCM1000 series power supply will operate within specifications at altitudes up to 16,404 feet above sea level. The power supply will not be damaged when stored at altitudes of up to 30,000 feet above sea level.

Humidity

The LCM1000 series power supply will operate within specifications when subjected to a relative humidity from 20% to 90% non-condensing. The LCM1000Q-T can be stored in a relative humidity from 10% to 95% non-condensing.

Vibration

The LCM1000 series will pass the following vibration specifications:

Non-Operating Random Vibration

Acceleration	2.7	gRMS	
Frequency Range	10-2000	Hz	
Duration	20	Mins	
Direction	3 mutually perpendicular axis		
PSD Profile	FREQ (Hz)	SLOPE (db/oct)	PSD (g ² /Hz)
	10	/	0.009
	200	-2.66	0.009
	500	/	0.004

Operating Random Vibration

Acceleration	1.0	gRMS	
Frequency Range	10 – 500	Hz	
Duration	20	Mins	
Direction	3 mutually perpendicular axis		
PSD Profile	FREQ (Hz)	SLOPE (db/oct)	PSD (g ² /Hz)
	5	11	0.00003
	10-50	/	0.00004
	100	-10	0.00003

ENVIRONMENTAL SPECIFICATIONS

Shock

The LCM1000 series power supply will pass the following shock specifications:

Non-Operating Half-Sine Shock

Acceleration	30	G
Duration	18	mSec
Pulse	Half-Sine	
Number of Shock	3 shock on each of 6 faces	

Operating Half-Sine Shock

Acceleration	4	G
Duration	22	mSec
Pulse	Half-Sine	
Number of Shock	3 shocks in each of 6 faces	

POWER AND CONTROL SIGNAL DESCRIPTIONS

AC Input Connector

This connector supplies the AC Mains to the LCM1000 series.

- SK1 – Earth Ground
- SK1 – Line
- SK1 – Neutral

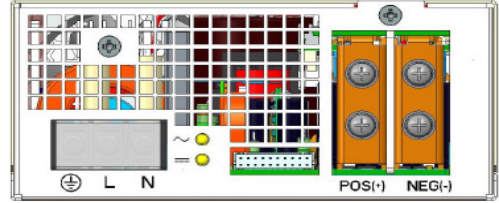

SK1 SK2 SK3 SK4

Output Connectors- SK3&SK4

These pins provide the main output for the LCM1000 series. The +Vout and the GND pins are the positive and negative rails, respectively, of the V_o main output of the LCM1000 series. The +Vout is electrically isolated from the power supply chassis.

- SK3 – +Vout
- SK4 – GND

Control Signals - SK2

The LCM1000 series SK2 contains 20 pins control signal header providing analogy control interface, standby power and i²C interface.

A0, A1, A2 - (Pin 6, Pin3, Pin1)

Please refer to “Communication Bus Descriptions” section.

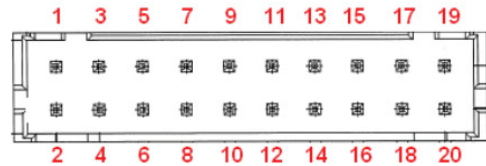

SK2

-VPROG, +VPROG - (Pin2, Pin8)

Positive and return connection of external supply for Margin Programming. The LCM1000 series power supply has a “margin” pin which accepts a 1-6Vdc signal referenced to a floating return that programs the output the entire adjustment range. -VPROG pin need to connect the main output/standby GND. Applying voltage greater than 6V may result to damage of PSU internal circuit.

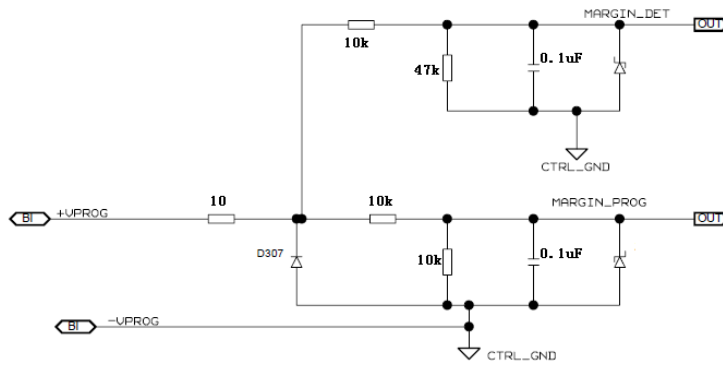

-Vsense, +Vsense - (Pin 4, Pin10)

This remote sense circuit will be designed to compensate for a power path drop around the entire loop of 0.5 volt. These pins should be connected as close to the loading as possible, If left open, the power supply will regulate the voltage at its output terminals but the voltage level at the load may go lower than the guaranteed spec.

POWER AND CONTROL SIGNAL DESCRIPTIONS

ISHARE - (Pin 5)

The main output has active load sharing. The output will share within 10% at full load. All current sharing functions are implemented internal to the power supply by making use of the ISHARE signal. The system connects the ISHARE lines between the power supplies. The supplies must be able to load share with up to 10 power supplies in parallel.

SDA1, SCL1, GND - (Pin 7, Pin9, Pin17)

Please refer to “Communication Bus Descriptions” section.

5VSB, GND - (Pin11, Pin12, Pin13)

The LCM1000 series power supply provides a regulated 5 volt 2 amp auxiliary output voltage to power critical circuitry that must remain active regardless of the on/off status of the power supply’s main output. The standby voltage is available whenever a valid AC input voltage is applied to the unit.

G_DCOK_C, G_DCOK_E - (Pin14, Pin16)

G_DCOK_C is a power good signal and is pulled LOW by the power supply to indicate that the output is within regulation. When any output voltage falls out of regulation, G_DCOK_C will be de-asserted to a HIGH state. Below is the connection of G_DCOK_C and G_DCOK_E.

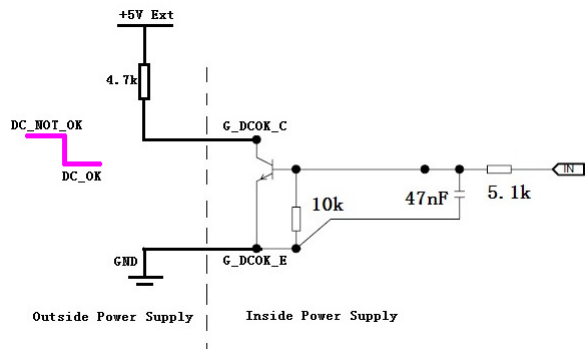

N/A - (Pin15)

Unused Pin

G_ACOK_C, G_ACOK_E - (Pin18, Pin20)

G-ACOK_C signal is used to indicate presence of AC input to the power supply. A logic “Low” level on this signal indicates AC input to the power supply is present. A Logic “High” on this signal indicates a loss of AC input to the power supply. Below is the connection of G_ACOK_C and G_ACOK_E.

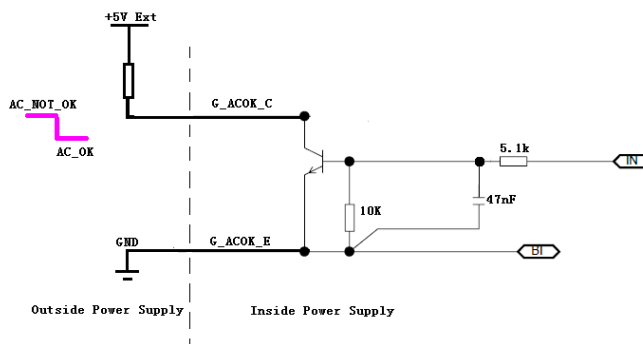

POWER AND CONTROL SIGNAL DESCRIPTIONS

INH_EN – (Pin19)

0.0 – 0.5V on this Pin will disable the main output. If left it open, the main output will enable.

COMMUNICATION BUS DESCRIPTIONS

I²C Bus Signal

The LCM1000 series contains enhanced monitor and control functions implemented via the I²C bus. The LCM1000 series I²C functionality (PMBus™ and FRU data) can be accessed via the output connector control signals. The communication bus is powered either by the internal 3.3V supply or from an external power source connected to the standby output (ie: accessing an unpowered power supply as long as the standby output of another power supply connected in parallel is on).

If units are connected in parallel or in redundant mode, the standby outputs must be connected together in the system. Otherwise, the I²C bus will not work properly when a unit is inserted into the system without the AC source connected.

Note: PMBus™ functionality can be accessed only when the PSU is powered-up. Guaranteed communication I²C speed is 100KHz.

SDA1, SCL1 (I²C Data and Clock Signals) - (pin7, pin 9)

I²C serial data and clock bus - these pins are internally pulled up to internal digital system controller.

A0, A1, A2 (I²C Address BIT 0, BIT1, BIT2 Signals) - (pin6, pin3, pin1)

These three input pins are the address lines A0, A1 and A2 to indicate the slot position the power supply occupies in the power bay and define the power supply addresses for FRU data and PMBus™ data communication. This allows the system to assign different addresses for each power supply. During I²C communication between system and power supplies, the system will be the master and power supplies will be slave.

They are internally pulled up to internal 3.3V supply with a 2K ohm resistor.

I²C Bus Communication Interval

The interval between two consecutive I²C communications to the power supply should be at least 50ms to ensure proper monitoring functionality.

I²C Bus Signal Integrity

Recommend to pull up the SDA and SCL pin with 2.2K ohm resistors in the system side. The noise on the I²C bus (SDA, SCL lines) due to the power supply will be less than 450mV peak-to-peak. This noise measurement should be made with an oscilloscope bandwidth limited to 20MHz.

COMMUNICATION BUS DESCRIPTIONS

I²C Bus Internal Implementation, Pull-ups and Bus Capacitances

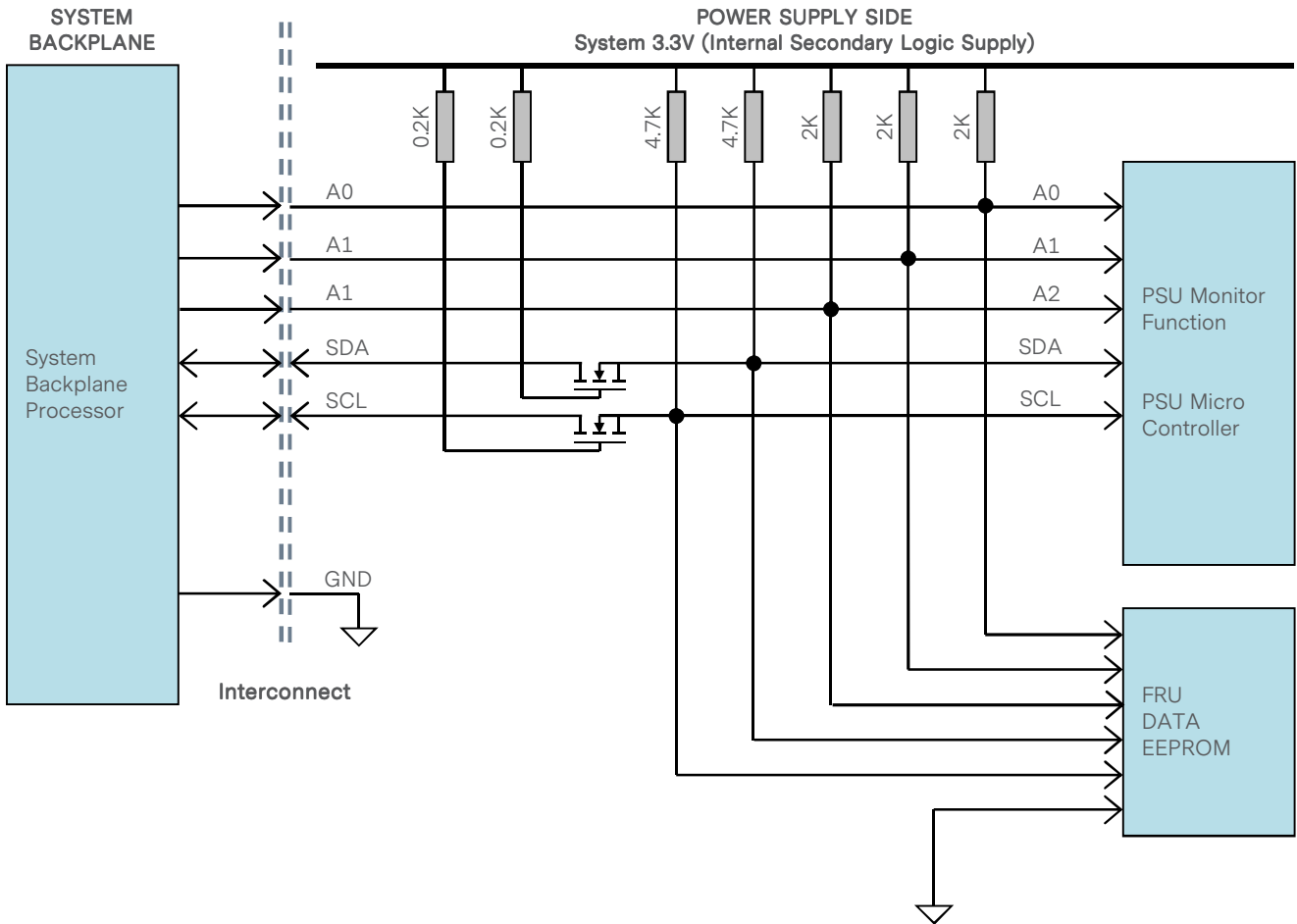

I²C Bus - Recommended external pull-ups

Electrical and interface specifications of I²C signals (referenced to standby output return pin, unless otherwise indicated):

Parameter	Condition	Symbol	Min	Type	Max	Unit
SDA, SCL recommended external bus capacitance		C_{ext}	-	5	-	pF
Recommended external pull-up resistor	1 to 5 PSU	R_{ext}	-	2.2	-	Kohm

COMMUNICATION BUS DESCRIPTIONS

Device Addressing

The LCM1000 series will respond to supported commands on the I²C bus that are addressed according to pins A0, A1 and A2 of output connector.

Address pins are held HIGH by default via pulled up to internal 3.3V supply with a 2K ohm resistor. To set the address as “0”, the corresponding address line should be pulled down to logic ground level. Below tables show the address of the power supply with A0, A1 and A2 pins set to either “0” or “1”:

PSU Slot	Slot ID Bits			PMBus™ Address
	A2	A1	A0	
1	0	0	0	B0h
2	0	0	1	B2h
3	0	1	0	B4h
4	0	1	1	B6h
5	1	0	0	B8h
6	1	0	1	BAh
7	1	1	0	BCh
8	1	1	1	BEh*

* Default PMBus™ address is BEh

COMMUNICATION BUS DESCRIPTIONS

Logic Levels

LCM1000 series power supply I²C communication bus will respond to logic levels as per below:

Logic High: 5.1V nominal (Spec is 2.1V to 5.5V)**

Logic Low: 500mV nominal (Spec is 800mV max)**

**Note: Artesyn 73-769-001 I²C adapter was used.

Timings

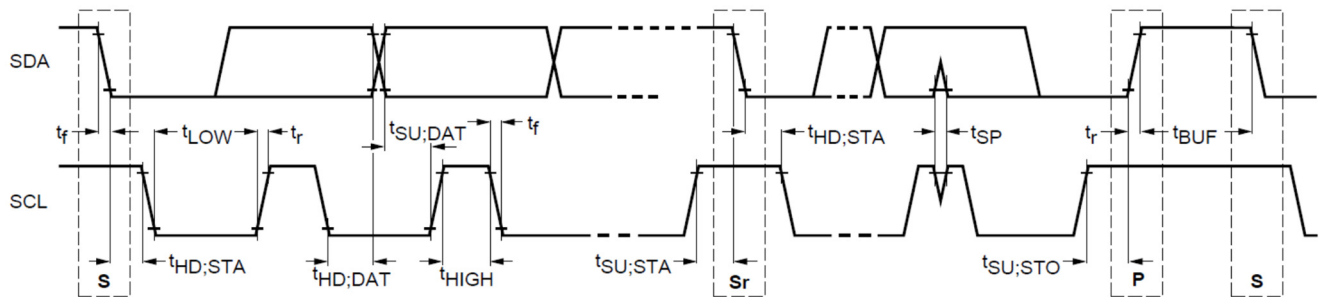

Parameter	Symbol	Standard-Mode Specs		Actual Measured		Unit
		Min	Max			
SCL clock frequency	f_{SCL}	10	100	98		KHz
Hold time (repeated) START condition	$t_{HD;STA}$	4.0	-	4.5		uS
LOW period of SCL clock	t_{LOW}	4.7	-	5.9		uS
HIGH period of SCL clock	t_{HIGH}	4.0	-	4.3		uS
Setup time for repeated START condition	$t_{SU;STA}$	4.7	-	4.5		uS
Data hold time	$t_{HD;DAT}$	0	3.45	1.2		uS
Data setup time	$t_{SU;DAT}$	250	-	4500		nS
Rise time	t_r	-	1000	SCL = 850	SDA = 903	nS
Fall time	t_f	-	300	SCL = 298	SDA = 590	nS
Setup time for STOP condition	$t_{SU;STO}$	4.0	-	5.2		uS
Bus free time between a STOP and START condition	t_{BUF}	4.7	-	60***		uS

***Note: Artesyn 73-769-001 I²C adapter (USB-to-I2C) and Universal PMBus™ GUI software was used.

COMMUNICATION BUS DESCRIPTIONS

I²C Synchronization

The LCM1000 series power supply might apply clock stretching. An addressed slave power supply may hold the clock line (SCL) low after receiving (or sending) a byte, indicating that it is not yet ready to process more data. The system master that is communicating with the power supply will attempt to raise the clock to transfer the next bit, but must verify that the clock line was actually raised. If the power supply is clock stretching, the clock line will still be low (because the connections are open-drain).

The maximum time out condition for clock stretching for LCM1000 series power supply is 25 msec.

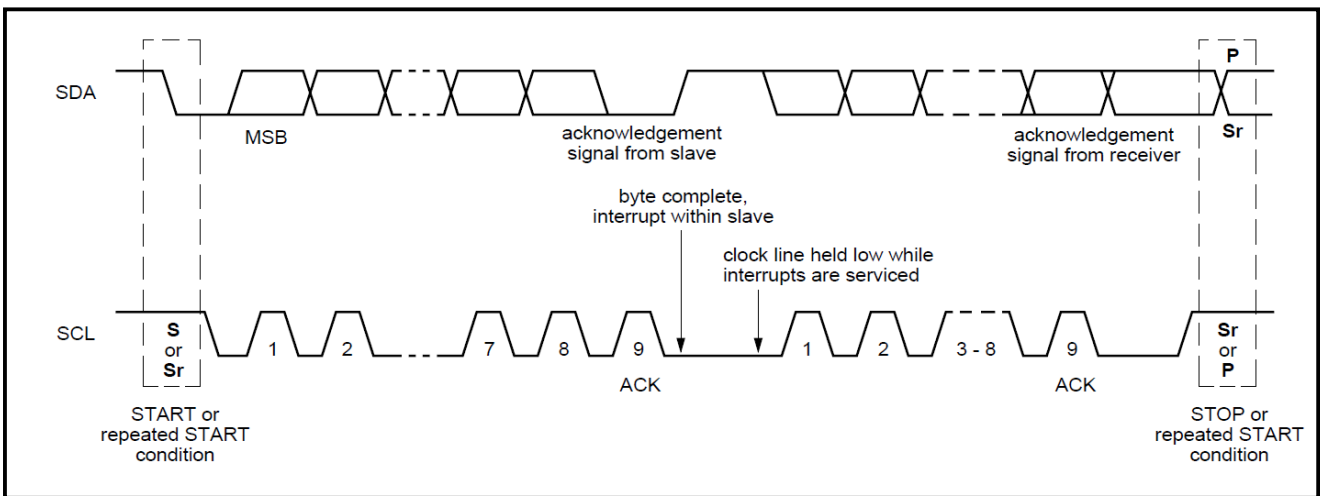

PMBUS™ SPECIFICATIONS

The LCM1000 series is compliant with the industry standard PMBus™ protocol for monitoring and control of the power supply via the I²C interface port.

LCM1000 Series PMBus™ General Instructions

Equipment Setup

The following is typical I²C communication setup:

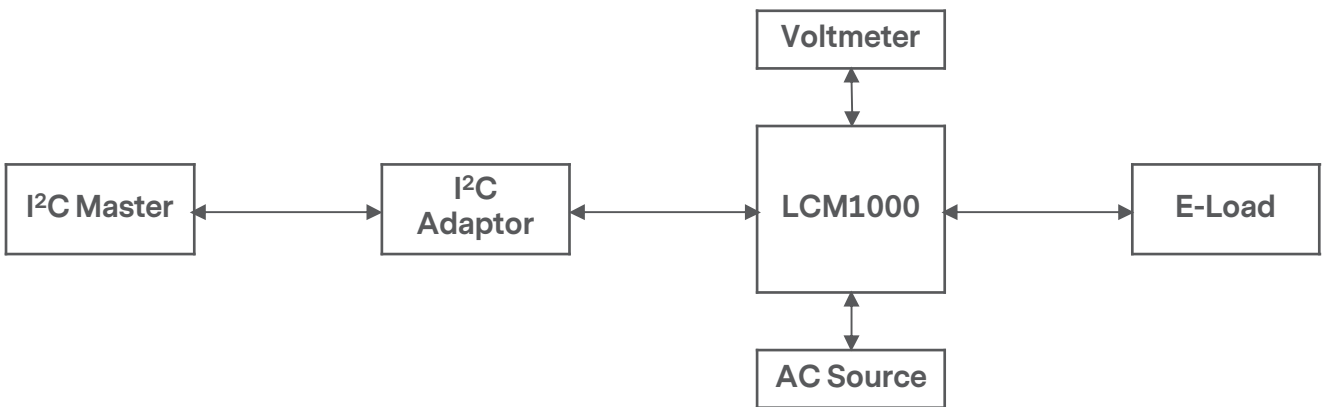

PMBus™ Writing Instructions

When writing to any PMBus™ R/W registers, ALWAYS do the following:

Disable Write Protect (command 10h) by writing any of the following accordingly:

Levels: 00h - Enable writing to all writeable commands

20h - Disables write except 10h, 01h, 00h, 02h and 21h commands

40h - Disables write except 10h, 01h, and 00h commands

80h - Disable write except 0x00h

To save changes on the USER PMBus™ Table:

Use send byte command: 15h STORE_USER_ALL

Wait for 5 seconds, turn-off the PSU, wait for another 5 seconds before turning it on.

PMBUS™ SPECIFICATIONS

The LCM1000 Series Supported PMBus™ Command List:

Command Code	Command Name	Default Value	Access Type	Data Bytes	Data Format	Description
01h	OPERATION	80	R/W	1	B	Used to turn the unit ON/OFF in conjunction with the input INH_EN pin.
02h	ON_OFF_CONFIG	1E	R	1	B	Configures the combination of INH_EN pin and serial communication commands needed to turn the unit ON/OFF.
03h	CLEAR_FAULTS	-	S	1		
10h	WRITE_PROTECT	80	R/W	1	MSF	Used to Control Writing to the PMBus Device 80h - Disables write except 10h 40h - Disables write except 10h, 01h, 00h 20h - Disables write except 10h,01h,00h,02h and 21h commands 00 -Enables write to all writeable commands.
15h	STORE_USER_ALL	-	S	0		Copies the Operating memory table to the matching USER non-volatile memory.
20h	VOUT_MODE	17	R	1	B	Specifies the mode and parameters of Output Voltage related Data Formats
21h	VOUT_COMMAND	-	R/W	2	Linear	Sets the Output Voltage Reference Default Value: LCM1000L: 1800(12V) LCM1000Q: 3000(24V) LCM1000W: 6000(48V) LCM1000U: 4800(36V) LCM1000N: 1E00(15V)
24h	VOUT_MAX	-	R	2	Linear	Sets the max adjustable output voltage limit. Default Value: LCM1000L: 1A66(13.12V) LCM1000Q: 34CC(26.40V) LCM1000W: 6999(52.80V) LCM1000U: 4F33(39.60V) LCM1000N: 2100(16.5V)
3Ah	FAN_CONFIG_1_2	99h	R	1	Bitmapped	Read only to reflect setting of fans
3Bh	FAN_COMMAND_1	-	R/W	2	Linear	Default:0% Valid Range: 0-100%
3Ch	FAN_COMMAND_2	-	R/W	2	Linear	Default:0% Valid Range: 0-100%
40h	VOUT_OV_FAULT_LIMIT	-	R/W	2	Linear	Sets Output Over voltage threshold. Default Value: LCM1000L: 2066(16.20V) LCM1000Q: 40CC(32.40V) LCM1000W:8199(64.80V) LCM1000U: 6133(48.60V) LCM1000N: 2700(19.5V)
41h	VOUT_OV_FAULT_RESPONSE	80	R	1	MSF	Unit Latches OFF. Resets on INH_EN or CONTROL pin recycle or AC recycle.

PMBUS™ SPECIFICATIONS

The LCM1000 Series Supported PMBus™ Command List:

Command Code	Command Name	Default Value	Access Type	Data Bytes	Data Format	Description
42h	VOUT_OV_WARN_LIMIT	-	R	2	Linear	Sets Over-voltage Warning threshold. Default Value: LCM1000L: 1C57(14.16V) LCM1000Q:35DC(26.93V) LCM1000W: 6E66(55.19V) LCM1000U: 5500(42.50V) LCM1000N: 2366(1770V)
43h	VOUT_UV_WARN_LIMIT	-	R	2	Linear	Sets Under-voltage Warning threshold. Default Value: LCM1000L: 1466(10.20V) LCM1000Q: 28CC(20.40V) LCM1000W: 4CCC(38.40V) LCM1000N: 1800(12V)
44h	VOUT_UV_FAULT_LIMIT	2800	R/W	2	Linear	Sets Under-voltage Fault threshold. Default Value: LCM1000L: 1400(10.0V) LCM1000Q: 28CC(20.40V) LCM1000W:4CCC(38.40V) LCM1000U: 3C00(30V) LCM1000N: 1799(11.79V)
45h	VOUT_UV_FAULT_RESPONSE	80	R	1	MSF	Turn PSU OFF
46h	IOUT_OC_FAULT_LIMIT	-	R/W	2	Linear	Sets the Over current threshold in Amps. Default Value:
47h	IOUT_OC_FAULT_RESPONSE	C0	R	1	MSF	OCP ride through. If OCP persists.
4Ah	IOUT_OC_WARN_LIMIT	-	R	2	Linear	Sets the Over Current Warning threshold in Amps.
4Fh	OT_FAULT_LIMIT	-	R	2	Linear	Secondary ambient temperature Fault threshold, in °C. LCM1000L: EBB0 (118 °C) LCM1000Q: EB80 (112 °C) LCM1000W: EBB0 (118 °C) LCM1000U: EBB0 (118 °C) LCM1000N: EBB0(118 °C)
50h	OT_FAULT_RESPONSE	F8	R	1	MSF	Turn PSU OFF and will retry indefinitely
51h	OT_WARN_LIMIT	-	R	2	Linear	Secondary ambient temperature warning threshold, in °C. Default Value: LCM1000L: EB90 (114 °C) LCM1000Q: EB60 (108 °C) LCM1000W: EB48 (105 °C) LCM1000U: EB90 (114 °C) LCM1000N: EB90 (114 °C)
5Eh	POWER_GOOD_ON	-	R	2	Linear	Sets the threshold by which the Power Good signal is asserted. Default Value: LCM1000L: 1357(9.67V) LCM1000Q: 2E00(23.0V) LCM1000W: 5C28(46.08V) LCM1000U: 40CC(32.40V) LCM1000N: 1957(12.67V)

PMBUS™ SPECIFICATIONS

The LCM1000 Series Supported PMBus™ Command List:

Command Code	Command Name	Default Value	Access Type	Data Bytes	Data Format	Description
5Fh	POWER_GOOD_OFF	-	R	2	Linear	Sets the threshold by which the Power Good signal is de-asserted. Default Value: LCM1000L: 1199(8.79V) LCM1000Q: 2B33(21.60V) LCM1000W: 5C28(46.08V) LCM1000U: 4000(32.00V) LCM1000N: 1900(12.5V)
60h	TON_DELAY	EB20	R	2	Linear	Sets the time (sec), from start condition (Power ON) until the output starts to rise.
61h	TON_RISE	DA80	R	2	Linear	Sets the time (ms), for the output rises from 0 to regulation. LCM1000L: DA80 (20ms) LCM1000Q: DA80 (20ms) LCM1000W: DBC0 (30ms) LCM1000U: DA80 (20ms) LCM1000N: DA80(20ms)
64h	TOFF_DELAY	DA80	R	2	Linear	Sets the time (ms), from a stop condition (Power OFF) until the output starts to drop (converter OFF).
78h	STATUS_BYTE	00	R	1	Binary	Returns the summary of critical faults
	b7 - BUSY					A fault was declared because the device was busy and unable to respond.
	b6 - OFF					Unit is OFF
	b5 - VOUT_OV					Output over-voltage fault has occurred
	b4 - IOUT_OC					Output over-current fault has occurred
	b3 - VIN_UV					An input under-voltage fault has occurred
	b2 - TEMPERATURE					A temperature fault or warning has occurred
	b1 - CML					A communication, memory or logic fault has occurred.
b0 - NONE OF THE ABOVE					A Fault Warning not listed in bits[7:1] has occurred.	
79h	STATUS_WORD	0000	R	2	Binary	Summary of units Fault and warning status.
	b15 - VOUT					An output voltage fault or warning has occurred
	b14 - IOUT/POUT					An Output current or power fault or warning has occurred.
	b13 - INPUT					An input voltage, current or power fault or warning as occurred.
	b12 - MFR					A manufacturer specific fault or warning has occurred.
	b11 - POWER_GOOD#					The POWER_GOOD signal is de-asserted

PMBUS™ SPECIFICATIONS

The LCM1000 Series Supported PMBus™ Command List:

Command Code	Command Name	Default Value	Access Type	Data Bytes	Data Format	Description
79h	b10 – FANS					A fan or airflow fault or warning has occurred.
	b9 – OTHER					A bit in STATUS_OTHER is set.
	b8 – UNKNOWN					A fault type not given in bits [15:1] of the STATUS_WORD has been detected.
	b7 – BUSY					A fault was declared because the device was busy and unable to respond.
	b6 – OFF					Unit is OFF
	b5 – VOUT_OV					Output over-voltage fault has occurred
	b4 – IOUT_OC					Output over-current fault has occurred
	b3 – VIN_UV					An input under-voltage fault has occurred
	b2 – TEMPERATURE					A temperature fault or warning has occurred
	b1 – CML					A communication, memory or logic fault has occurred.
	b0 – NONE_OF_THE_ABOVE					A fault or warning not listed in bits[7:1] of this byte has occurred.
7Ah	STATUS_VOUT	00	R	1	Binary	Output voltage related faults and warnings
	b7					VOUT Over-voltage Fault
	b6					VOUT Over-voltage warning
	b5					VOUT Under-voltage Warning
	b4					VOUT Under-voltage Fault
	b3					VOUT_MAX Warning, an attempt has been made to set output to a value higher than the highest permissible voltage.
	b2					TON_MAX_FAULT
	b1					TOFF_MAX Warning
	b0					reserved
7Bh	STATUS_IOUT	00	R	1	Binary	Output Current related faults and warnings
	b7					IOUT Over current Fault
	b6					IOUT Over current And Low Voltage shutdown Fault
	b5					VOUT Under-voltage Warning
	b4					VOUT Under-voltage Fault
	b3					VOUT_MAX Warning, an attempt has been made to set output to a value higher than the highest permissible voltage.
	b2					TON_MAX_FAULT
	b1					TOFF_MAX Warning
	b0					reserved

PMBUS™ SPECIFICATIONS

The LCM1000 Series Supported PMBus™ Command List:

Command Code	Command Name	Default Value	Access Type	Data Bytes	Data Format	Description
7Dh	STATUS_TEMPERATURE	00	R	1	Binary	Temperature related faults and warnings
	b7					Overtemperature Fault
	B6					Overtemperature Warning
	B5					Under temperature Warning
	B4					Under temperature Fault
b3,b2,b1,b0					reserved	
7Eh	STATUS_CML	00	R	1	Binary	Communications, Logic and Memory
80h	STATUS_MFR_SPECIFIC	0	R	1	Binary	Manufacturer Status codes
88h	READ_VIN	-	R	2	Linear	Returns input Voltage in Volts ac
8Bh	READ_VOUT	-	R	2	Linear	Returns the actual, measured voltage in Volts.
8Ch	READ_IOUT	-	R	2	Linear	Returns the output current in amperes.
8Dh	READ_TEMPERATURE_1	-	R	2	Linear	PSU Air inlet temp (inside PSU)
8Eh	READ_TEMPERATURE_2	-	R	2	Linear	PSU Air inlet temp (inside PSU)
96h	READ_POUT	-	R	2	Linear	Returns the output power, in Watts.
97h	READ_PIN	-	R	2	Linear	Returns the input power, in Watts
99h	MFR_ID	4E,59,53,45,54, 52,41,07	R/W	8	ASCII	ARTESYN
9Ah	MFR_MODEL	-	R/W	8	ASCII	
9Bh	MFR_REVISION	-	R/W	2	ASCII	
9Ch	MFR_LOCATION	-	R/W	8	ASCII	Laguna
9Dh	MFR_DATE	-	R/W	8	ASCII	Manufacture Date, ASCII format structure : YYMMDD
9Eh	MFR_SERIAL	-	R/W	13	ASCII	13 CHAR
A0h	MFR_VIN_MIN	EAD0	R	2	Linear	Minimum Input Voltage (90Vac)
A1h	MFR_VIN_MAX	FA10	R	2	Linear	Maximum Input Voltage (264Vac)
A2h	MFR_IIN_MAX	DA60	R	2	Linear	Maximum Input Current (19A)
A4h	MFR_VOUT_MIN	-	R	2	Linear	Minimum Output Voltage Regulation Window. Default Value: LCM1000L: 1599 (10.80V) LCM1000Q: 2B33 (21.60V) LCM1000W: 5600 (43.0V) LCM1000U: 40CC (32.40V)
A5h	MFR_VOUT_MAX	-	R	2	Linear	Maximum Output Voltage. Default Value: LCM1000L:1A66 (13.20V) LCM1000Q:34CC (26.40V) LCM1000W:6999 (52.80V) LCM1000U: 4F33 (39.60V)
A6h	MFR_IOUT_MAX	-	R	2	Linear	Maximum Output Current
A7h	MFR_POUT_MAX	0B0C	R	2	Linear	Maximum Output Power
A8h	MFR_TAMBIENT_MAX	EA30	R	2	Linear	Maximum Operating Ambient Temperature (Secondary Ambient) (70 °C)
A9h	MFR_TAMBIENT_MIN	-	R	2	Linear	Minimum Operating Ambient Temperature (Secondary Ambient)

APPLICATION NOTES

Current Sharing

The LCM1000 series main output is equipped with current sharing capability. This will allow up to 10 power supplies to be connected in parallel for higher power application. Current share accuracy is typically 10% of full load. The I²C Line should be connected separately. The minimum load at parallel operation is 1% of the total Output current that the units can deliver.

The table below shows the derated maximum power capacity when units are in parallel configuration. This is to consider the 10% load sharing tolerance.

Number of Units in Parallel (N)	Maximum Output power Rated + [(N-1) x 0.9] x Rated, Where: Rated - 1000W, N - Number of PSU in Parallel
Stand-alone	1000W
2	1900W
3	2800W
..	..
....
10	9100W

APPLICATION NOTES

Redundant Operation Connection Diagram

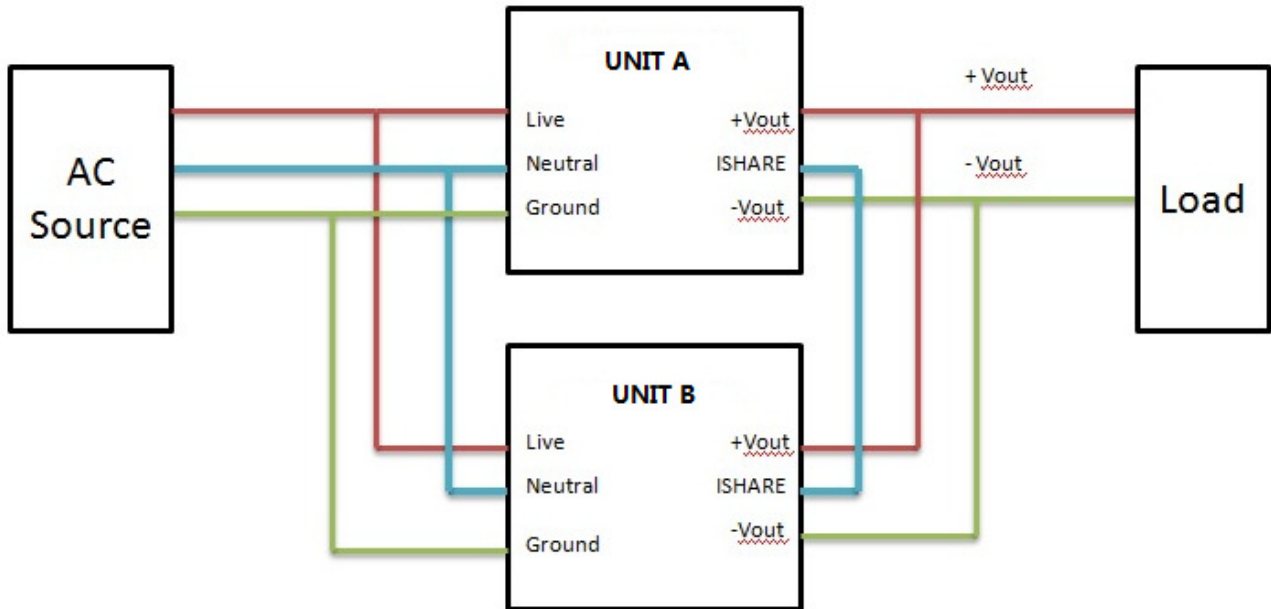

Note 1 Above figure shows connection for two power supply. Similar connection must be followed for higher number of power supplies connected. The maximum number of power supply is 10.

Note 2 PMBus Address should be set unique per power supply.

Note 3 The G_DCOK_C pins and G_ACOK_C pins can be connected together to the system DCOK and ACOK input pins. This can also be wired separately so the system will still continue to operate in case 1 PSU fails.

Note 4 Read I_o per power supply. The reported I_o power supply should be the same or similar.

APPLICATION NOTES

Block Diagram

Below is the block diagram of the LCM1000 series power supply.

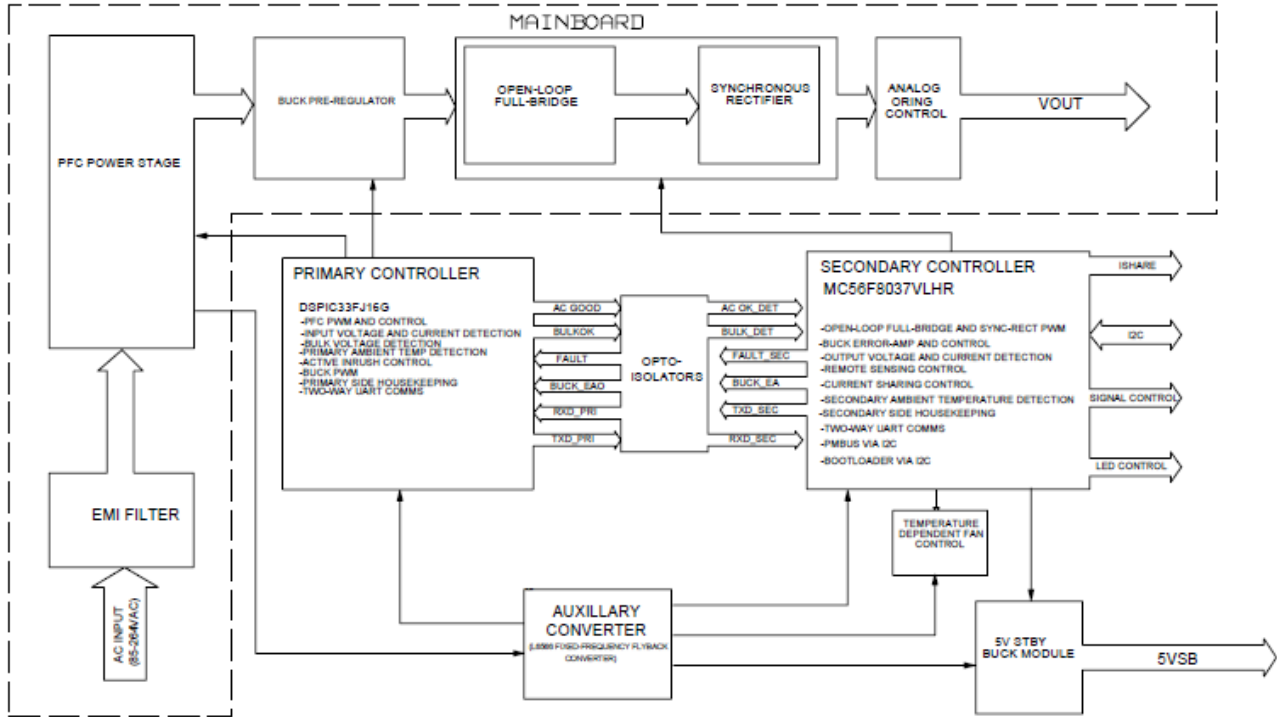

APPLICATION NOTES

Output Ripple and Noise Measurement

The setup outlined in the diagram below has been used for output voltage ripple and noise measurements on the LCM1000 series power supply. When measuring output ripple and noise, a scope jack in parallel with a 0.1uF ceramic chip capacitor, and a 10 uF tantalum capacitor should be used. Oscilloscope should be set to 20 MHz bandwidth for this measurement.

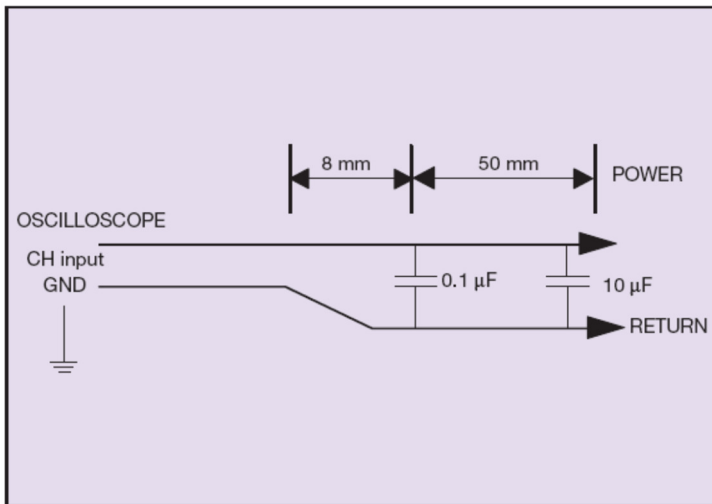

RECORD OF REVISION AND CHANGES

Issue	Date	Description	Originators
1.0	05.14.2015	First Issue	L. Lee
1.1	10.10.2015	Updated the “EMC” Section	L. Lee
1.2	01.07.2016	Updated the I ² C detail	L. Lee
1.3	04.27.2016	Update the LCM1000L and LCM1000W Performance Curve	L. Lee
1.4	05.04.2016	Update remote sense description	K. Wang
1.5	12.17.2016	Update the LCM1000U and LCM1000N Performance Curve	L. Lee
1.6	04.28.2017	Update the leakage current to 240Vac 0.3mA per safety confirm	K. Wang
1.7	05.14.2019	Update mating connector	K. Wang
1.8	10.18.2019	Update model numbers and altitude	L. Lee
1.9	03.26.2020	Update isolation voltage	L. Lee
2.0	05.30.2020	Update the leakage current	K. Wang
2.1	06.17.2020	Update 62368-1 cert information	L. Lee
2.2	10.09.2020	Update PFC and DC DC Switching Frequency	K. Wang
2.3	10.20.2020	Update 21h command to R/W	L. Lee
2.4	05.11.2021	Update size information	K. Wang
2.5	07.07.2021	1. Update the dynamic condition 2. Update the format	L. Lee
2.6	08.10.2021	Update the isolation voltage and new picture with new logo	K. Wang
2.7	01.20.2022	Update the 3Ah,3Bh,3Ch an control command Update the PMBus Logo Update UKCA Mark Update the timing part error	K. Wang
2.8	01.10.2023	Update LCM1000Q output current from 41.7 to 42A to consistent with label	K. Wang
2.9	04.24.2023	Update SEMI F47 compliance information Update the LCM1500W output voltage range	L. Lee



For international contact information,
visit advancedenergy.com.

powersales@aei.com (Sales Support)
productsupport.ep@aei.com (Technical Support)
+1 888 412 7832

ABOUT ADVANCED ENERGY

Advanced Energy (AE) has devoted more than three decades to perfecting power for its global customers. AE designs and manufactures highly engineered, precision power conversion, measurement and control solutions for mission-critical applications and processes.

Our products enable customer innovation in complex applications for a wide range of industries including semiconductor equipment, industrial, manufacturing, telecommunications, data center computing, and medical. With deep applications know-how and responsive service and support across the globe, we build collaborative partnerships to meet rapid technological developments, propel growth for our customers, and innovate the future of power.

PRECISION | POWER | PERFORMANCE

Specifications are subject to change without notice. Not responsible for errors or omissions. ©2020 Advanced Energy Industries, Inc. All rights reserved. Advanced Energy®, and AE® are U.S. trademarks of Advanced Energy Industries, Inc.

LCM1000 Rev.04.24.23_#2.9